

# THE PLACEBOOK

BATTERSEA POWER STATION

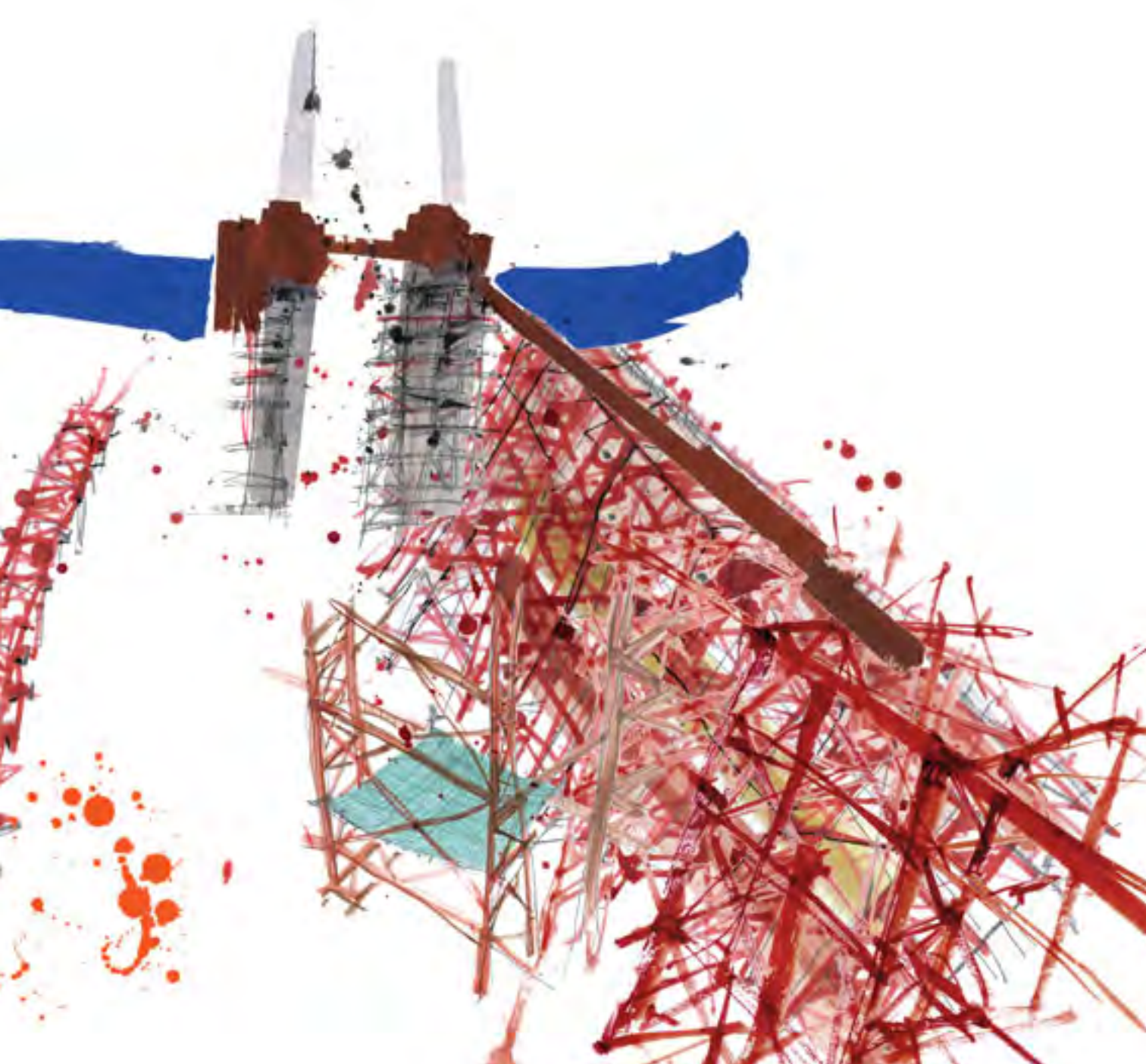



# THE PLACEBOOK

BATTERSEA POWER STATION

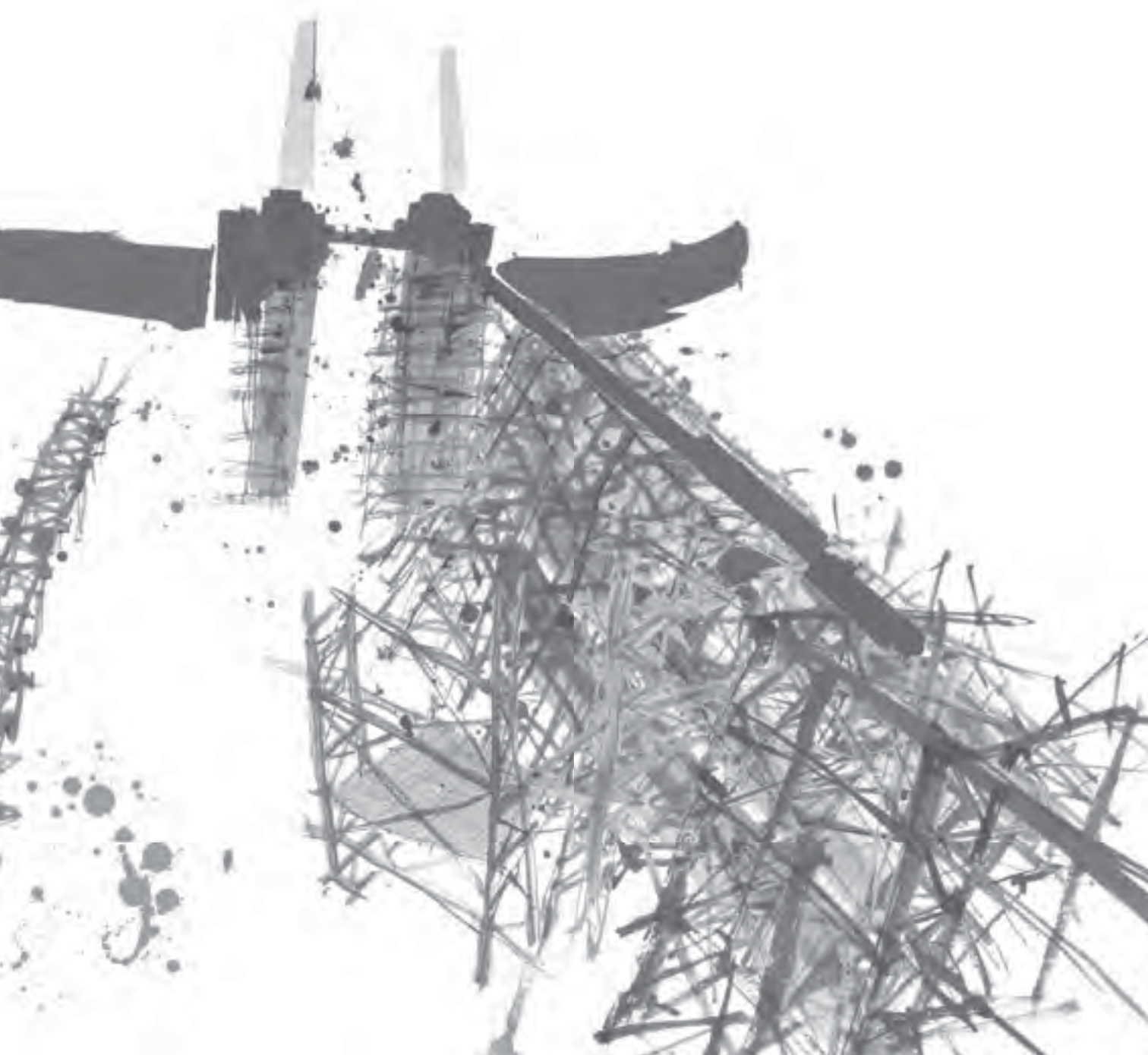

Published in 2014 by Battersea Power Station  
Development Company and JTP Press  
©Battersea Power Station Development Company  
and JTP Press

Battersea Power Station Development Company  
188 Kirtling Street, London SW8 5BN  
T: +44 (0)20 7501 0688  
www.batterseapowerstation.co.uk

JTP Press  
John Thompson & Partners / JTP Cities  
23-25 Great Sutton Street, London EC1V 0DN  
T: +44 (0)20 7017 1780  
www.jtp.co.uk

ISBN: 978-0-9929135-0-2

Typeset in Futura, FS Albert and Chronicle Display  
Printed in the United Kingdom



Builder of Distinction  
**Setia**  
S P SETIA BHD GROUP

**Sime Darby**  
Property  
Developing Sustainable  
Futures



  
**BATTERSEA  
POWER STATION**  
DEVELOPMENT COMPANY LIMITED

**jtp** cities

**ual:** university  
of the arts  
london  
camberwell  
chelsea  
wimbledon

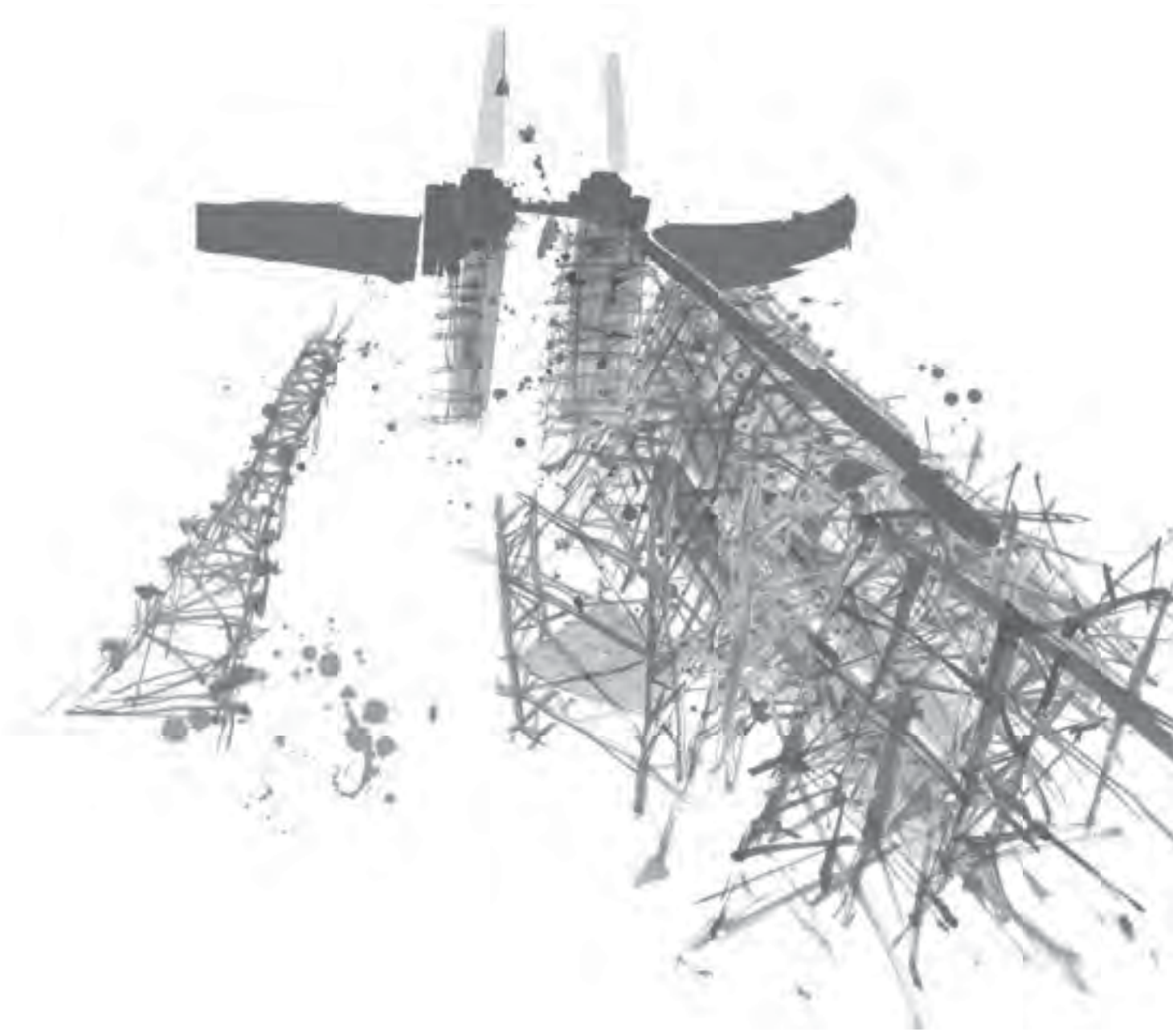

# CONTENTS



**06 / Overview**  
what is a placebook?



**08 / Back Story**  
from power to place



**16 / Masterplan**  
the Viñoly vision



**22 / Process**  
thinking Battersea



**84 / Shopping**  
you shop, we drop



**104 / Working**  
what is business as usual?



**126 / Living**  
there's no place like home



**150 / Learning**  
hungry for knowledge



**26 / Manifesto**  
the value of values

up

**40 / Placemaking**  
making it all add up



**42 / Evolving**  
how does your garden grow



**60 / Playing**  
easy like Sunday morning



**170 / Connecting**  
joining up the dots



**190 / Branding**  
the marque of a great place

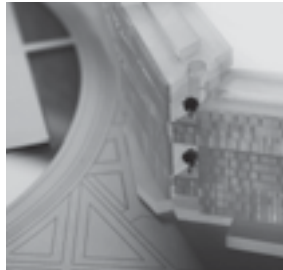

**210 / Beginning**  
getting started



**218 / Postscript**  
nurturing talent

# what is a **placebook**

Like everything we have in mind for Battersea Power Station, our Placebook is a unique concept designed to inspire and delight.





Battersea Power Station holds a special place in the hearts of Londoners with its distinctive form having graced the capital's skyline for as long as anyone can remember. It has also inspired a generation of artists, photographers and designers, so its image is recognised across the world as an icon of Britain's industrial heritage.

But The Power Station also exudes an air of mystery. Having stood redundant for more than three decades, this remarkable building is something few have experienced first hand. There's a real sense of awe that comes from standing in the vast spaces of the Turbine Halls, or the beautiful Art Deco interiors of Control Room A.

So as construction begins, we are aware of the need to respond to the level of curiosity and anticipation surrounding the project and, more importantly, exceed the wildest dreams of an expectant public by transforming The Power Station into an exciting and authentic urban quarter, unlike anything seen before.

To create a unique place requires a unique approach, which is where our Placebook comes in: the outcome of months of workshops, expert discussions, urban research and study tours, this volume sets out our masterplan vision, Manifesto and a whole host of strategic thinking about Placemaking.

Our approach to The Power Station project is ambitious, complex, nuanced and multi-faceted, producing a proposition that requires a genuine

team effort from thousands of talented individuals over the next 10-15 years. So we felt the need to create a document capable of inspiring each and every one of us, to serve as a touchstone and help guide decision-making at those moments when what is urgent threatens to overshadow what is truly important.

So you can think of The Placebook as a handbook or manual for all the designers, agents, investors, consultants and business partners to refer to, as they go about making one of London's signature achievements of the 21st century. Or, if you'd rather, as a piece of 'thought leadership', designed to stimulate creative conversations about how to make a great place.

But more than anything, this Placebook is our commitment writ large. It's where we begin to put our belief system into action.

We believe we've taken the freshest and most appetising of raw ingredients and produced a totally new recipe for how to combine the design, content, management and identity of a place. We think that as a result Battersea Power Station will be, quite simply, a feast for the soul. The final ingredient is You. So please, read on.

*Rob Tincknell*

*CEO, Battersea Power Station  
Development Company*

## BACK STORY

# from power to place

Great cities are in constant flux, from barely perceptible day-by-day changes through to radical reworking of entire districts – keeping urban areas relevant to contemporary life.



It's easy to forget that until the 20th century, rivers were the lifeblood of most cities, supporting the transport of raw materials, foodstuffs, livestock and manufactured goods. With their banks lined with wharves and warehouses, these areas functioned as places of commerce, rather than the leisure environments most have now become.

The mighty Thames was a prime example of this, so it should come as no surprise that the area around Battersea Power Station – located right alongside the river and in very close proximity to the centre of London – has a long history of serving the needs of the city.

But what is particularly fascinating is just how frequently this area entirely changed its purpose to address historical shifts in land usage in support of contemporary life. From its agricultural beginnings, through manufacturing and processing, to energy generation and servicing – whatever London has needed, this location has stepped up to the mark and delivered.

What follows is this unfolding story – and the radical thinking that is driving its future transformation into a unique post-industrial city quarter.



The Domesday Book lists Battersea as:  
18 small holdings, 7 mills, 17 ploughs and  
50 hogs roaming over 82 acres of woodland.

Its net worth was 75 pounds,  
9 shillings and eight pence.

### **AGRARIAN TO INDUSTRIAL**

In Anglo-Saxon times, the land around Battersea was largely marshes, until techniques were developed to culvert the streams and drain the land, so it could support market gardening. Battersea could then lay claim to some of the best growing conditions in England and home to more than a quarter of all native wild plant species. This fertile landscape supplied the capital with a large proportion of its daily fruit and vegetables, much of it transported downstream on the river. Accounts show that not only was the humble carrot grown here, but also melons and it was reputedly the first place in England to grow asparagus – known then as ‘Battersea Bundles’.

But as the capital grew, more and more land around Battersea gave way to industrial uses. Even as far back as the 1600s, the Huguenots had settled on the banks of the River Wandle and built mills for the dyeing, bleaching and printing of silk and calico. By the 1800s, a vitriol (sulphuric acid) factory and horizontal airmill (linseed oil/malt grinding) had arrived and the Industrial Revolution continued to usher in a host of other operations including potteries, copper works and lime kilns throughout the century.

### **MERRIMENT & MOBILITY**

Historically Battersea has never just been a place of work – it was also well known for its Sunday Fairs which featured horse and pigeon racing, as well as gambling, drinking and other activities frowned upon by Victorian society. After 1835, Battersea Fields came under new ownership and the area descended into deeper lawlessness, being the scene of frequent fights and brawls outside of seedy taverns. To address this problem, Queen Victoria’s ‘Commission for Improving the Metropolis’ purchased a large part of Battersea Fields, with 200 acres being assigned for parkland and 100 acres being made available for the building of residential villas.

The redesignation of this land coincided with the outward development of London and Battersea soon became the location for desirable suburban developments such as ‘New Town’ and ‘Park Town’. The status of these new places was greatly enhanced by the opening of both Battersea Park and Chelsea Suspension Bridge in 1858, with the latter linking the previously isolated area to the prosperous neighbourhoods of Chelsea on the north bank of the Thames.



Charles Darwin is known to have frequented the famous Red House Tavern in this area, perhaps arriving by a ferry which crossed over from the Chelsea bank. The public house is the subject of a watercolour painting (1830) in Wandsworth's Museum collection and records show it had been a favourite rendezvous place since Tudor times, located in a genteel place where day-trippers arrived by boat from London to promenade, paint, write and read poetry. One newspaper article from 1843 describes how 'During the summer months, thousands repair thither to enjoy the delights of a short water excursion and the smiling landscape by which it is surrounded.'

But when Grosvenor Railway Bridge was constructed in 1860 to provide a connection to Victoria Station, the site occupied by The Power Station today became isolated from the residential community that had developed around Battersea Park.

At that point a series of open reservoirs occupied this land, but these were subsequently redeveloped by the Vauxhall Waterworks Company into a water treatment plant in response to public health concerns and in particular the prevalence of cholera.

Following this, viaducts to carry trains into Waterloo to the south of the waterworks were constructed and with the so-called 'Battersea Tangle' of railway infrastructure complete, the future site of The Power Station became isolated from the surrounding urban areas.

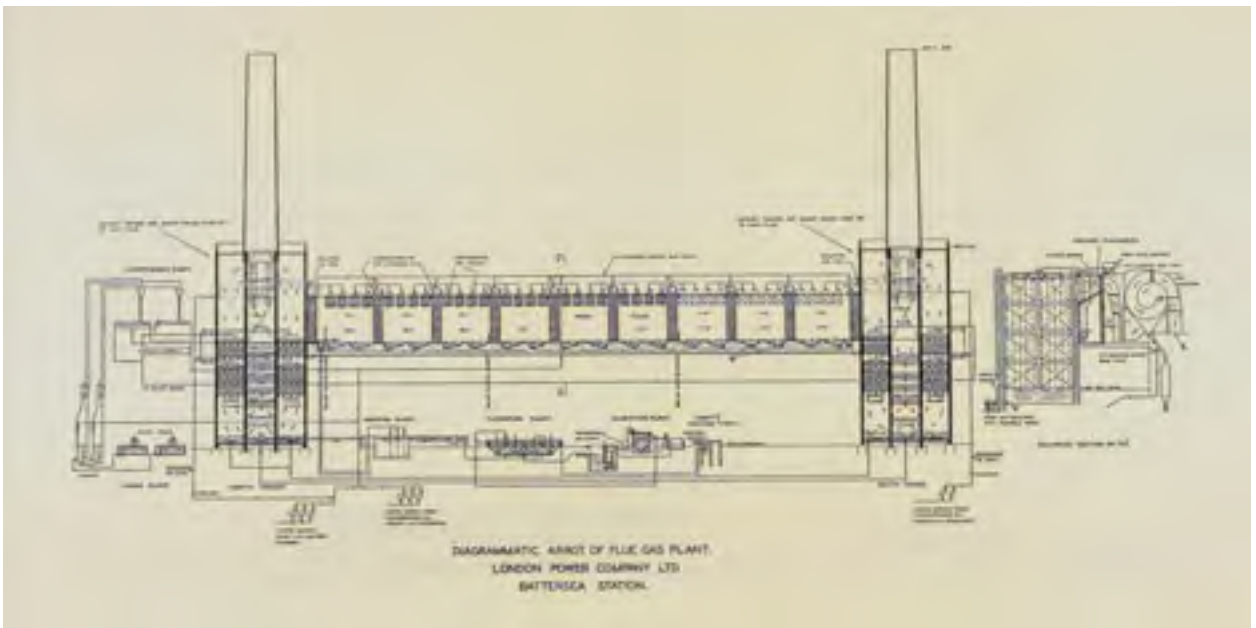



## POWER FOR THE PEOPLE

By the late 1920s London's population was burgeoning and its infrastructure needed a major boost to meet the demand for electricity. In 1925, ten smaller electricity companies merged to form the London Power Company with the aim of rationalising the generating industry and improving its efficiency.

Because of its proximity to the river for deliveries of coal and its relative lack of residential neighbours, Battersea was selected as a suitable location for a new power station for west London in 1927 and construction for a new coal-fired power station commenced in 1929. Turbine Hall A took ten years to build and was completed just before the outbreak of World War II.

At the time of construction, Battersea Power Station was considered to be the cutting edge of electricity generation and Sir Giles Gilbert Scott's 'Cathedral of Power' an architectural triumph. A bold but subtle brick design, with detail concentrated at the upper levels, it was described by Architect and Building News as 'a harmonising of engineering structure with architectural expression' and represented the first time a contemporary architectural character had been applied to a power station as a building type. It was an approach that set the standard for the next generation of industrial 'brick cathedrals', which were built across the country during the 1940s and 1950s.

But it wasn't just the exterior of the building that was remarkable; the inside was graced by J. Theo Halliday's remarkable Art Deco interiors, which drew on a prevailing cinema aesthetic to dress a largely functional industrial space.

Few people realise that the reason Battersea Power Station dwarfs other generating plants in London such as Bankside, Deptford and Lotts Road, is because it is actually two power stations built side by side in a single building. For a time, only two chimneys graced the skyline, until Gilbert Scott's grand design was completed in the late 1940s with the construction of Turbine Hall B.



# Battersea Power Station was an industrial icon, producing power for London's homes and businesses for over half a century.

## But since the onset of the post-industrial era, planners, architects and developers have struggled to find a viable new purpose.

### **INDUSTRIAL TO POST-INDUSTRIAL**

Fast forward to the late 1970s and increasing concerns with pollution, urban air quality and public health saw the government switch towards cleaner fuel supplies. Coal burning power stations, like other dirty industries, were no longer seen as having a place in the centre of cities and innovations in the way electrical energy could be generated, stored and distributed meant plants could be located in areas remote from the populations they served.

This turn of events led to the closure of Battersea Power Station Turbine Hall A in 1975, followed by Turbine Hall B in 1983. But before the lights were finally turned out, the building was granted a Grade II\* listing, to ensure the much-loved landmark would be preserved as an iconic piece of industrial heritage.

These circumstances reflected changes happening throughout Western Europe and in North America at the time, as economies entered their post-industrial period and employment underwent a painful but inevitable shift away from heavy manufacturing towards the service industry.

For city planners and leaders, the 1970s and 1980s were challenging times, with vast tracts of land becoming redundant and many interesting or historically significant industrial buildings in urgent need of repurposing in order to avoid being lost for good, due to a lack of maintenance and persistent vandalism. In London, hundreds of acres of docklands were flattened to create a new financial centre at Canary Wharf, which bankrupted the original developers due to infrastructure costs and delays – the Achilles' heel of many post-industrial projects.

Closer to the centre of London, things were a little easier and the riverfront warehouses of Wapping and Shad Thames were soon converted into characterful apartments – although it would be many years before the shops, cafés and other facilities that make everyday life enjoyable arrived. With the arrival of Tate Modern in the year 2000, London acquired what is perhaps a perfect example of post-industrial adaptive reuse – with the former Bankside Power Station converted by Swiss architects Herzog & de Meuron into what is now the world's most popular museum of modern art.

This approach to redevelopment can be found across Europe, from the Gare d'Orsay in Paris to Fiat's Lingotto Building in Turin, with awe-inspiring buildings and spaces of the industrial age remade into stimulating workspaces and cultural destinations.







## **ALWAYS THE BRIDESMAID**

So how did the area in and around Battersea respond to this latest shift in contemporary city life?

Remarkably, The Power Station managed to avoid significant bombing during World War II, unlike many of the surrounding sites, where industry and homes were erased from the map. After the war, these areas were remade to service London's new needs, with the arrival of quantities of social housing, the relocated New Covent Garden Market and the Royal Mail Sorting Office.

But after its closure, the listed Power Station seemed to resist all efforts to emulate the post-industrial successes of similar buildings elsewhere.

Hopes were raised when the site was purchased in the mid-1980s by entrepreneur John Broome, who planned to build a family theme park in The Power Station. After gaining planning consent in 1986, work began with the demolition of the west wall and roof, to allow removal of generating equipment and intermediate floors inside.

But the financial crash of 1987 (Black Monday) marked the beginning of the end for Broome's ambitious scheme. By 1989 his leisure company had gone bust and all construction work stopped, leaving just the shell of The Power Station intact. Since then, many others have tried and failed to bring new life to the iconic building.

So what makes it different this time?

How have things changed to inspire renewed confidence? And what kind of visionary masterplan will it take to resurrect this industrial masterpiece?



the  
**Viñoly**  
vision

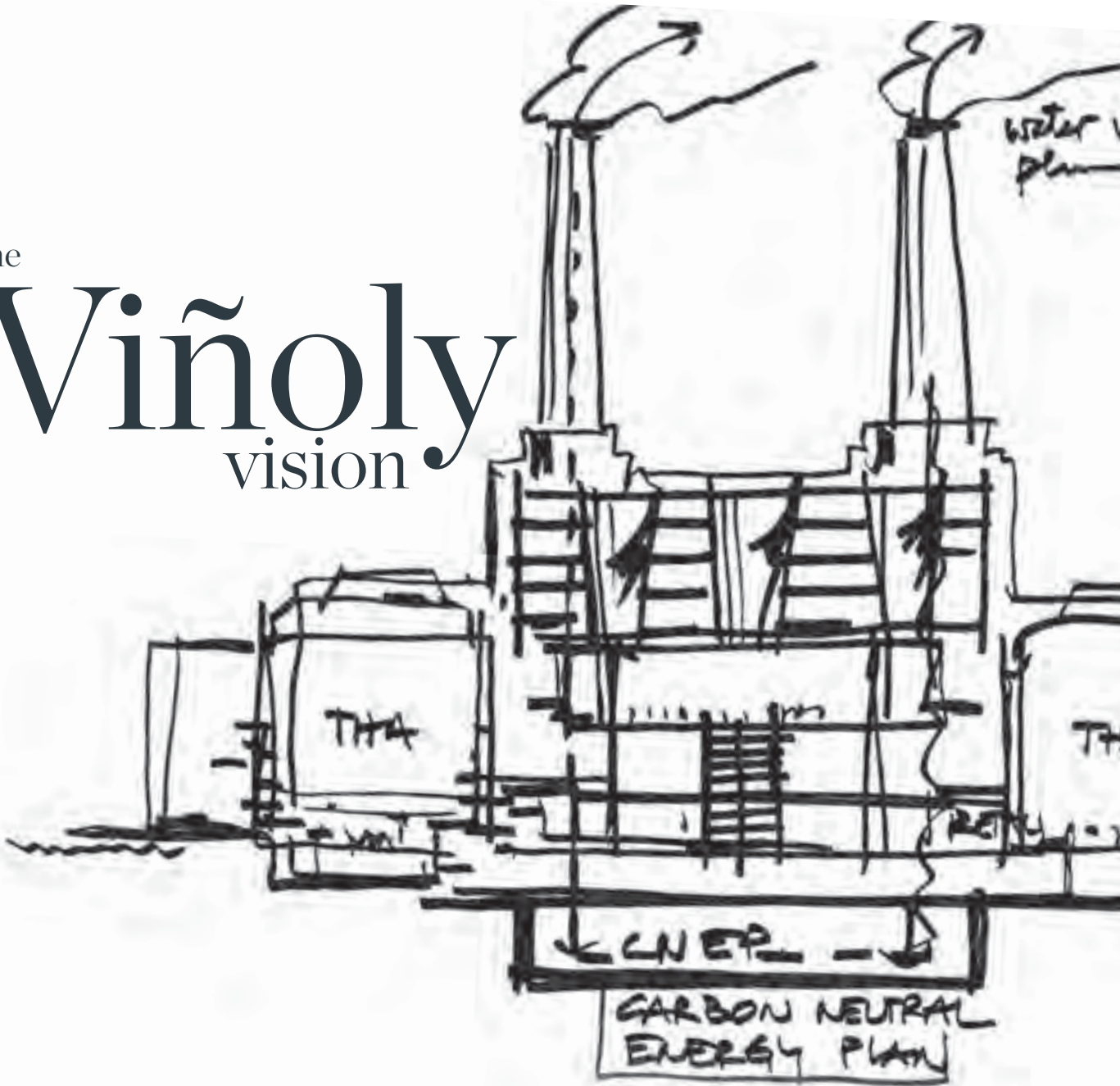



There have been many proposals for Battersea Power Station since it closed in 1983, but until now none have overcome the issue of access, or achieved the right mix of uses, density, look and feel.

Aerial photographs from the 1950s show The Power Station surrounded on all sides by the paraphernalia of the industrial age – the ‘Battersea Tangle’ of railway tracks, conveyor belts, riverside cranes, barges, service yards and all along the river frontage, a strange black landscape of coal supply.

People are conspicuous by their absence. But for those employed to keep the electricity flowing, this was a largely unpopulated corner of the capital and became ever more so as the 20th century progressed.

While urban isolation was of course one of the great attractions of the site for building a power station, it has proved one of the greatest challenges for masterplanning this area as a new city quarter.

Creating vitality, where previously there was none, required nothing less than a complete inversion of the existing situation – effectively re-connecting the site into its surrounding urban fabric so it could function as a logical extension of central London.

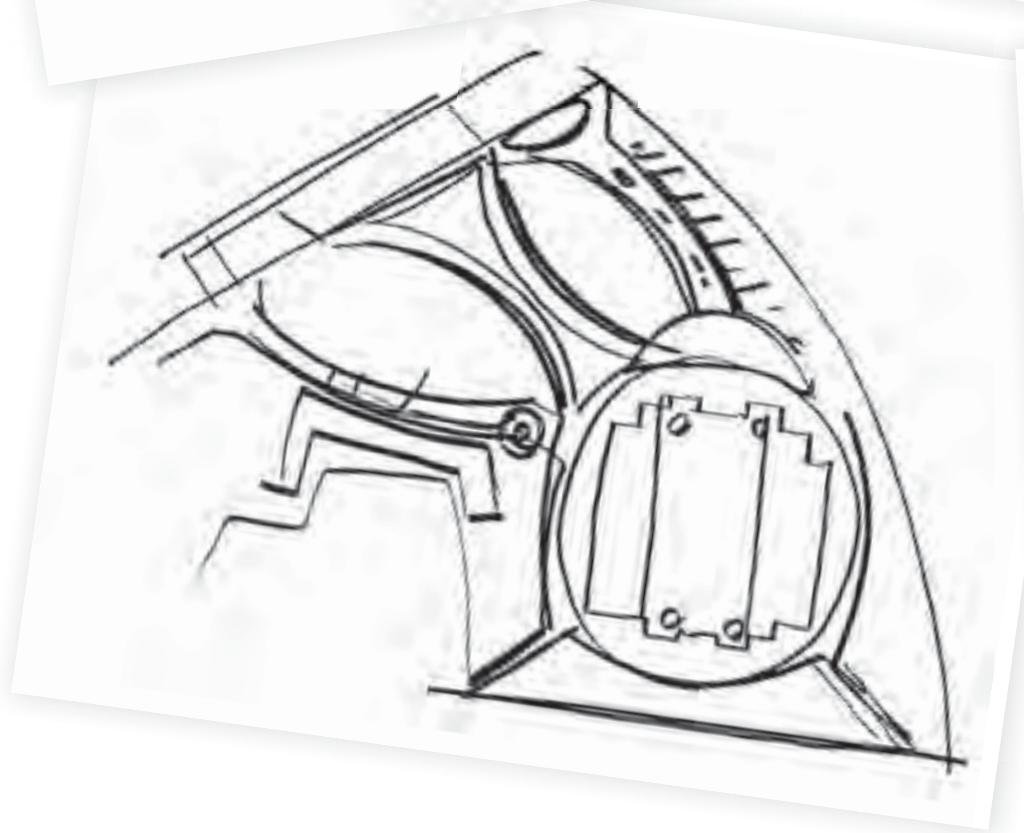
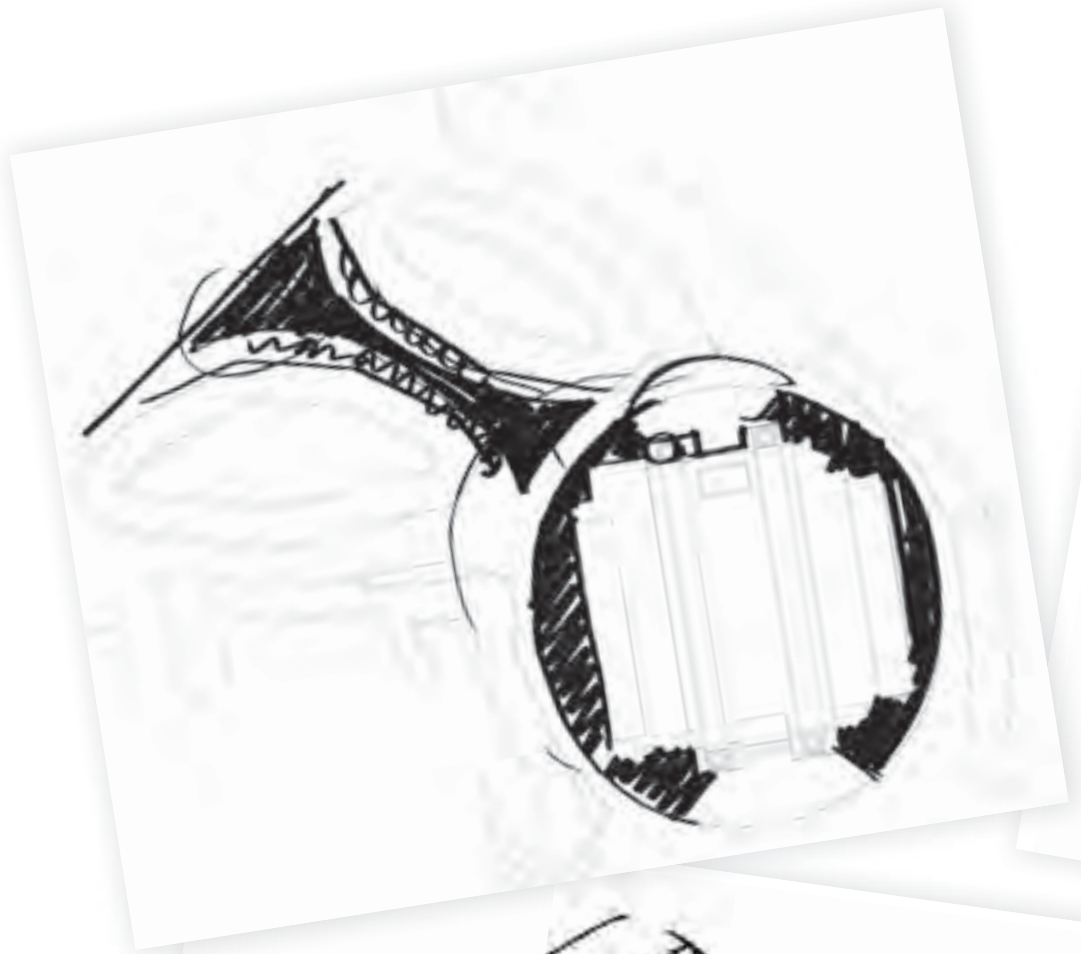

Rafael Viñoly's sketch design drawings for Battersea Power Station masterplan.

30 years in the making, an elegant solution to this has been created by renowned architect Rafael Viñoly, made possible by the final resolution of four critical issues that had stymied previous attempts at redevelopment:

### LANDHOLDING

Until recently the area surrounding The Power Station was an uncoordinated patchwork of landholdings – with differing views of the future. Today, acquisitions have concentrated this down into a handful of major players, working in partnership and committed to the comprehensive redevelopment of the Battersea/Nine Elms area.

### MOMENTUM

Earlier attempts to regenerate the site met with varying degrees of enthusiasm by the complex group of stakeholders who had a role in determining the future of the site. But in the last five years political will has helped to increase development momentum.

With a Government and Mayor committed to London as a pre-eminent world city, a Local Authority supporting change and heritage bodies eager to grasp this final opportunity to save The Power Station, a comprehensive planning framework has finally been developed for the area, providing a clear vision for the future.

### TRANSPORTATION

Since the site was decommissioned in 1983, a major obstacle for redevelopment has been solving the problem of how to get people to The Power Station. An agreement to extend the Northern Line on the Underground network and a funding strategy to make it happen has now literally placed the project 'on the map' – with Battersea Power Station tube stop due to open in 2020.

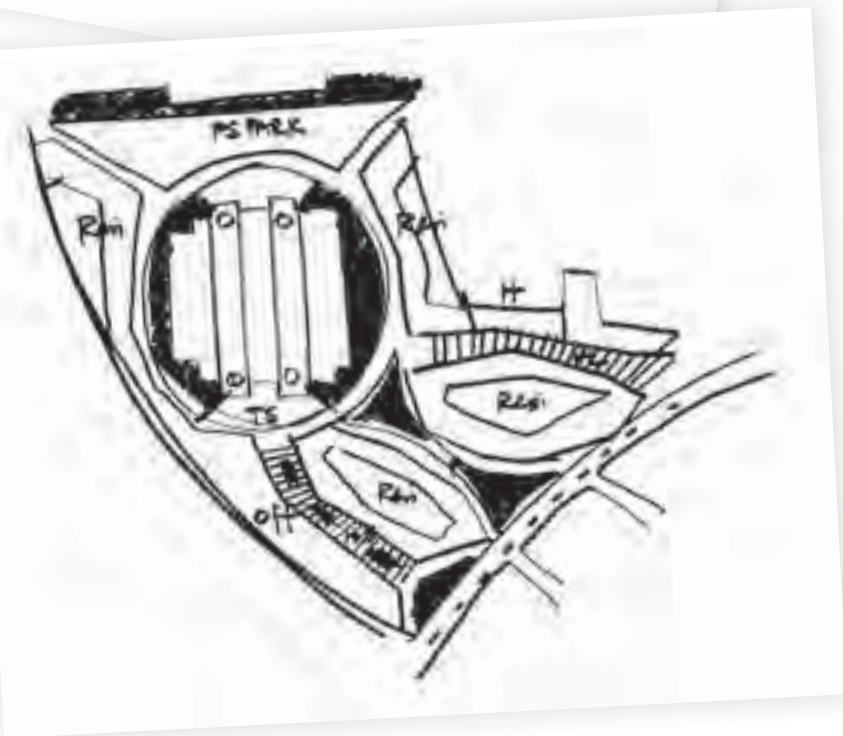
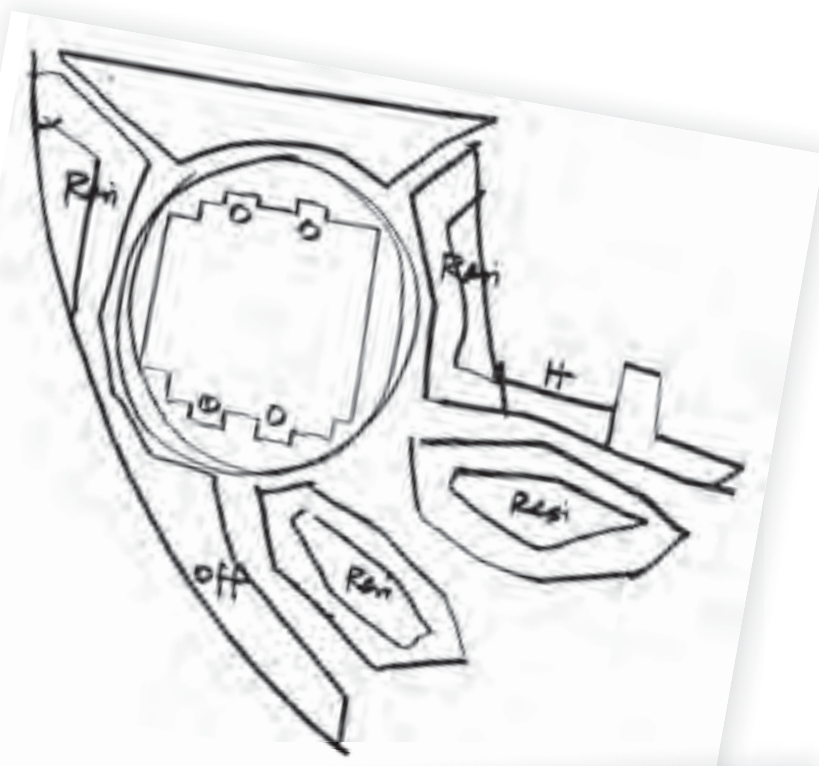

Rafael Viñoly's sketch design drawings for Battersea Power Station masterplan.

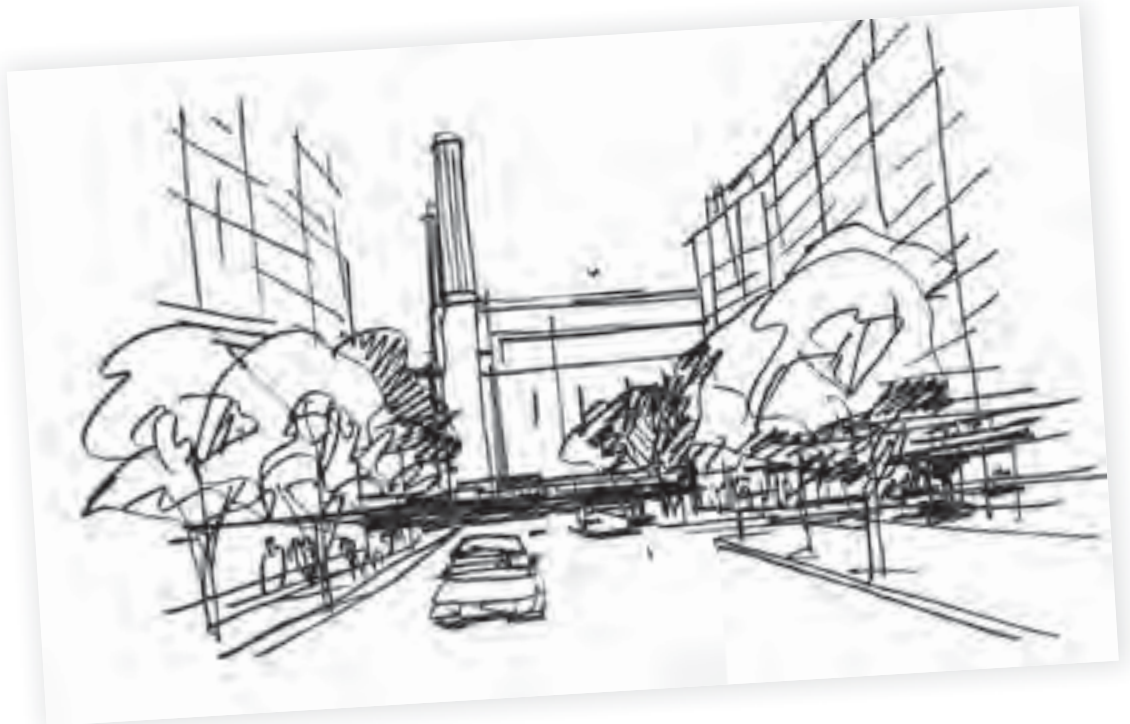
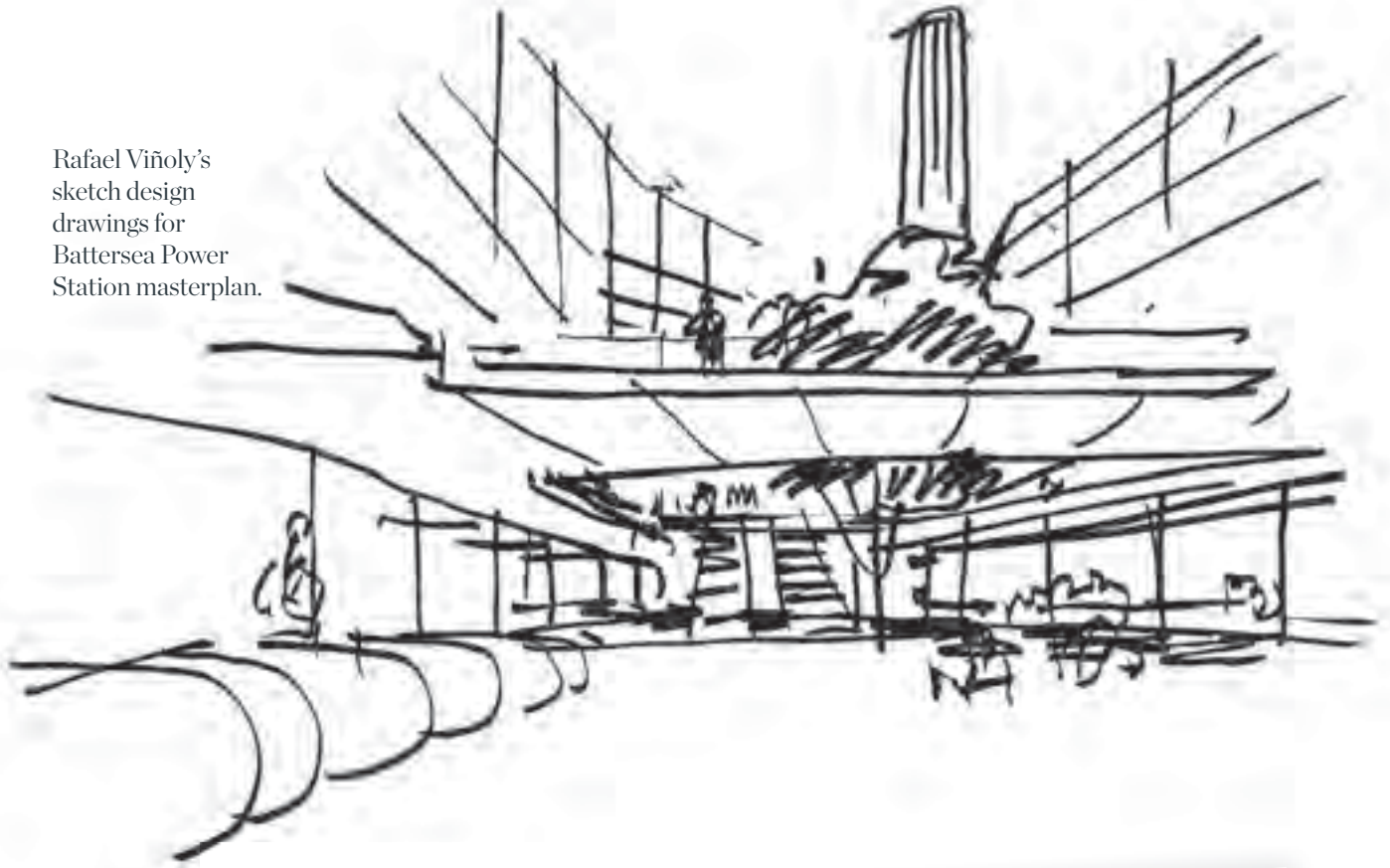

## **OWNERSHIP**

In 2012, Battersea Power Station was purchased by a Malaysian consortium including SP Setia Berhad – the country’s premier property developer; Sime Darby – one of the country’s largest businesses with a workforce of over 100,000 people; and the Employees’ Provident Fund – which is ranked among the world’s largest pension funds, serving over 13 million members.

With international property development expertise, financial acumen and the support of the Malaysian government, The Power Station has finally found itself under an ownership more than capable of delivery.

## **DENSITY**

With these four issues overcome, the final challenge to success at The Power Station was that of achieving critical mass. Dense urban living has been shown to be the most sustainable form of development, but it is also the key to creating a successful and viable new city quarter.

With density comes: a resident population large enough to form a healthy mixed community; a working population large enough to make the site active during the day; and retail and leisure facilities extensive and differentiated enough to make The Power Station a new destination for London throughout the day and night and all through the week.

## **MASTERPLAN BLOCKS**

The Rafael Viñoly masterplan has been designed to allow phased development of the project, starting on the western side of the site and moving to the east.

### **Phase 1**

This block sits to the west of The Power Station. It is predominantly residential on the upper floors with a range of active ground floor uses including retail, office space, food and beverage outlets and leisure facilities. The block is designed by Ian Simpson Architects and de Rijke Marsh Morgan (dRMM).

### **Phase 2**

The Grade II\* listed Power Station is the centrepiece of a new creative quarter containing a rich mixture of destination uses including retail, culture, education, leisure attractions, a multi-purpose venue, creative office space and some of the capital’s most unique residential accommodation. The building is being designed by Wilkinson Eyre Architects.

### **Phase 3**

This is the main gateway to the development, connecting the Northern Line Extension station with The Power Station. It brings together two of the world’s leading architecture practices: Gehry Partners and Foster + Partners. The Electric Boulevard, running through the middle of the phase, provides two levels of retail accommodation. A new community hub and children’s playground line the pedestrian route through The Prospect Park.

### **Phase 4**

This block will make up the eastern side of The Prospect and will have cafés and restaurants at ground floor associated with leisure and cultural facilities. Above this will be apartments around a private courtyard space.

### **Phase 6**

On the eastern side of The Power Station is the largest development block on the site. It contains terraces of apartments overlooking the Grade II\* building with active uses at ground floor level. Commercial office space is located along Pump House Lane.

### **Phases 5 and 7**

These residential blocks sit to the eastern edge of the site and will help to knit the development into the wider local Nine Elms context.







# thinking Battersea

The aim of the *Thinking Battersea* series was to explore proposed land uses, understand the current context, identify contemporary trends and speculate on the future.

With the Viñoly masterplan in place and the largest outline planning application ever submitted in London under review by the London Borough of Wandsworth, attention turned to the next level of visionary thinking, in order to develop the kind of Placemaking Strategies required to turn Battersea Power Station into one of the world's outstanding urban quarters.

With this in mind, consultant JTP Cities, well known as placemakers and community planners, was commissioned to curate and facilitate the *Thinking Battersea* series of workshops and discussions. This creative forum was established to explore proposed land uses for The Power Station project – in order to understand the current context, identify contemporary trends and speculate on future trajectories.

Half of the eight thematic sessions were organised around traditional mixed-use issues such as living, working, shopping and playing, the other four sessions took a more lateral or non-spatial approach and addressed evolving, learning, connecting and branding.

Each began with the presentation of a research paper by JTP Cities, outlining key issues for each theme. These were followed by a wide-ranging debate involving influential and groundbreaking experts who were carefully selected to address different aspects of each theme. Some were academics chosen to help explore theoretical issues, while others were consultants involved in trendspotting and speculation about the future. Many had invaluable practical experience of setting up successful urban ventures from first principles such as markets, arts cinemas and collaborative workspaces, or in activating public space through pop-up ventures, meanwhile uses and festivals.

Each expert presented a 10-15 minute 'provocation' to kick-start conversations, which challenged preconceptions or revealed new insights about the nature of place. Unusually for a visioning exercise, debate participants were drawn from all areas of the development team, not just those traditionally involved in scheme design, but also project management, construction, finance, sales & marketing and legal advisors, with the intention of creating a common understanding of the issues and fostering collective ownership of the emerging Power Station place strategy.

The expert discussions were followed by interactive workshops, designed by JTP Cities to build on the issues arising for each land-use theme and to consider implications and specific approaches for The Power Station masterplan in more detail. All research, debate and workshop material was captured and recorded in the 'Project Bible' – an online resource accessible to all member of the team, which was used to create the strategies set out in the subsequent chapters of The Placebook.

The development team and JTP Cities are indebted to the experts who participated in the *Thinking Battersea* series and helped inform the future of The Power Station.



#### EVOLVING EXPERTS

**Eric Reynolds**

*Founding Director, Urban Space Management  
(Meanwhile use)*

**Helen Marriage**

*Co-Director, Artichoke Trust  
(Art and public engagement)*

**Cathy Parker**

*Professor of Marketing & Retail Enterprise  
Manchester Metropolitan University  
(Place management)*

## thinking battersea.



discussion: **playing.**

## thinking battersea.



discussion: **shopping.**

## thinking battersea.



discussion: **working.**

### PLAYING EXPERTS

#### **Kitty Ross**

*Programme Director  
Mayor's Thames Festival  
(Thames Festival case study)*

#### **Lyn Goleby**

*Managing Director  
City Screen/Picturehouse Cinemas  
(Independent cinema)*

#### **Adrian Voce**

*Joint Director  
Play England  
(Playscapes)*

#### **Sara O'Reilly**

*Around Town & Kids Editor  
Time Out  
(London leisure and trends)*

### SHOPPING EXPERTS

#### **Greg Hodge**

*Director of Global Retail  
Iconoculture  
(Global retailing trends)*

#### **George Nicholson**

*Former Chairman of  
Trustees Borough Market,  
George Nicholson Photography  
(Borough Market case study)*

#### **Tom Savigar**

*Strategy & Insight Director  
The Future Laboratory  
(Future of retailing)*

#### **Martin Raymond**

*Co-founder  
The Future Laboratory  
(Future of retailing)*

#### **Jo Jackson**

*Marketing Director  
'i-am' beyond  
(Pop-up & retail experience)*

#### **Tim Jeffrey**

*Retail Director  
'i-am' associates  
(Pop-up & retail experience)*

### WORKING EXPERTS

#### **John Worthington**

*Co-founder  
DEGW  
(Office environment expert)*

#### **Rob Harris**

*Principal  
Ramidus Consulting Limited  
(Office pipeline)*

#### **Alex Homfray**

*Principal Consultant  
BOP Consulting  
(Creative industries)*

#### **Dauida Hamilton**

*of PLACEmaking – a collaborative  
network of workplace designers  
and change advisors  
(Future workstyles)*

#### **Jonathan Robinson**

*Founder  
The Hub  
(The Hub case study)*

## thinking battersea.



discussion: **living.**

## thinking battersea.



discussion: **learning.**

## thinking battersea.



discussion: **connecting.**

## thinking battersea.



discussion: **branding.**

### LIVING EXPERTS

#### **Stephen Bayley**

Writer  
(Session respondent)

#### **Azhar**

Director  
Conran + Partners  
(Future living)

#### **Dr David Heathcote**

Freelance Cultural Historian  
(Barbican case study)

#### **George Evans**

Managing Director  
John Paul (UK)  
(Concierge lifestyle)

### LEARNING EXPERTS

#### **Mark Dudek**

Principal  
Mark Dudek Associates  
(Early years design)

#### **Robin Baker OBE**

Director  
Ravensbourne  
(Ravensbourne case study)

#### **Kai Peters**

Chief Executive  
Ashridge Business School  
(Professional training & education)

#### **Jo Hargreaves**

Director  
Morris Hargreaves McIntyre  
(Audience development)

### CONNECTING EXPERTS

#### **David Barrie**

Principal Consultant  
David Barrie & Associates  
(Open-source placemaking)

#### **Tim Fendley**

Partner  
Applied  
(Wayfinding)

#### **Peter Williams**

CEO  
Better Bankside  
(BID case study)

#### **Saffron Woodcraft**

Director  
Social Life  
(Future communities)

### BRANDING EXPERTS

#### **Stephen Cheliotis**

Chief Executive  
The Centre for Brand Analysis  
(Superbrands)

#### **Simon Anholt**

Independent Policy Advisor  
(City branding)

#### **Wally Olins**

Chairman  
Saffron Brand Consultants  
(Place branding)

#### **Ayo Daramola-Martin**

Managing Director  
Admotus Marketing  
(Liverpool One case study)

# the value of values

How do you turn a year's thinking into simple principles that can inform how a place should be?

*Illustrations: Konstantinos Palaiologos*

Throughout the *Thinking Battersea* series, a number of specific issues reoccurred time and again in conversations, which suggested they were fundamental to the success of the project. These were distilled into an overarching ten point Manifesto for the project that captured the essence of The Power Station place brand – describing what it should be all about as an experience and what kinds of actions that demanded on our part.

The notion of a manifesto might seem anachronistic, or too associated with political or artistic thought – Marx's Communist Manifesto (1848), the Dada Manifesto (1916) or André Breton's tract on Surrealism (1924) spring to mind. However, what they all have in common is a courage of conviction rarely encountered in our era of short-term thinking and media spin.

In today's world we seem to expend more effort trying to convince people things are great than we do making them that way – an unhealthy attitude of 'why change the world when you can just change everyone's perception of it?'

Well we actually do want to change the world – or at least our contribution to it.

Manifestos stem from a desire to communicate new thinking and ideas, but in actual fact this is only their secondary purpose. What they are really about are values: people use manifestos to nail their colours to the mast, demonstrate commitment and set out what they truly believe in for others to witness. In this way they become guiding principles, ways of thinking that keep things on track and hold their creators to their word.

# BATTERSEA

P  
O  
W  
E  
R

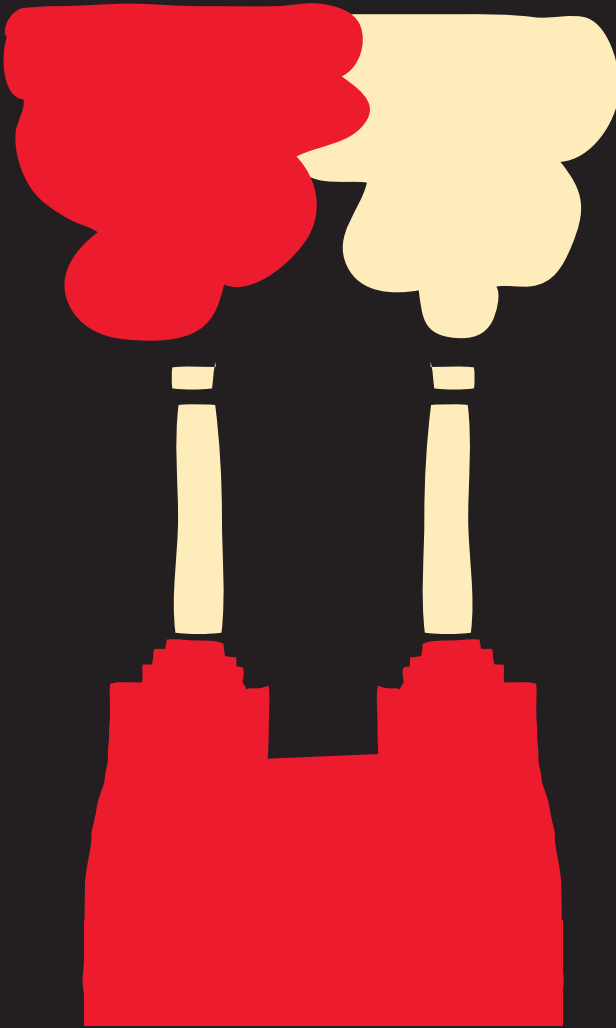

S  
T  
A  
T  
I  
O  
N

# MANIFESTO

## **NO DEFAULT**

Battersea Power Station is unique.

As the centrepiece of the Nine Elms masterplan, it will create its own value landscape.

To achieve this, we must adopt an innovative, integrated and highly collaborative mindset and then do everything possible to avoid the obvious.







## **BIG ADVENTURE**

The Power Station is intriguing. It makes people want to come and experience it for themselves.

We must build anticipation, exceed expectations, contradict the naysayers and let people be part of the adventure from the outset: they're our best advocates.

Let's not disappoint them.

03

AN

UNFOLDING

**AN  
UNFOLDING  
STORY**

Battersea Power Station will take 20 years to create and must make sense as a place every step of the way.

To evolve from a pioneer community to a mature city quarter needs careful curatorship, giving each stage its own magnetism.



STORY



**SYMBOLIC ACTION**

The reputation of Battersea Power Station is based on the principle that actions speak louder than words.

To foster a profound sense of belief in the place brand, we must make symbolic actions that are generous, truthful and unmissable.

**SHOWSTOPPER**

As a destination, Battersea Power Station must offer a guaranteed good time.

It's not the West End, it's the new Best End.

People will come because there is a myriad of new, different and interesting things to experience all year round.

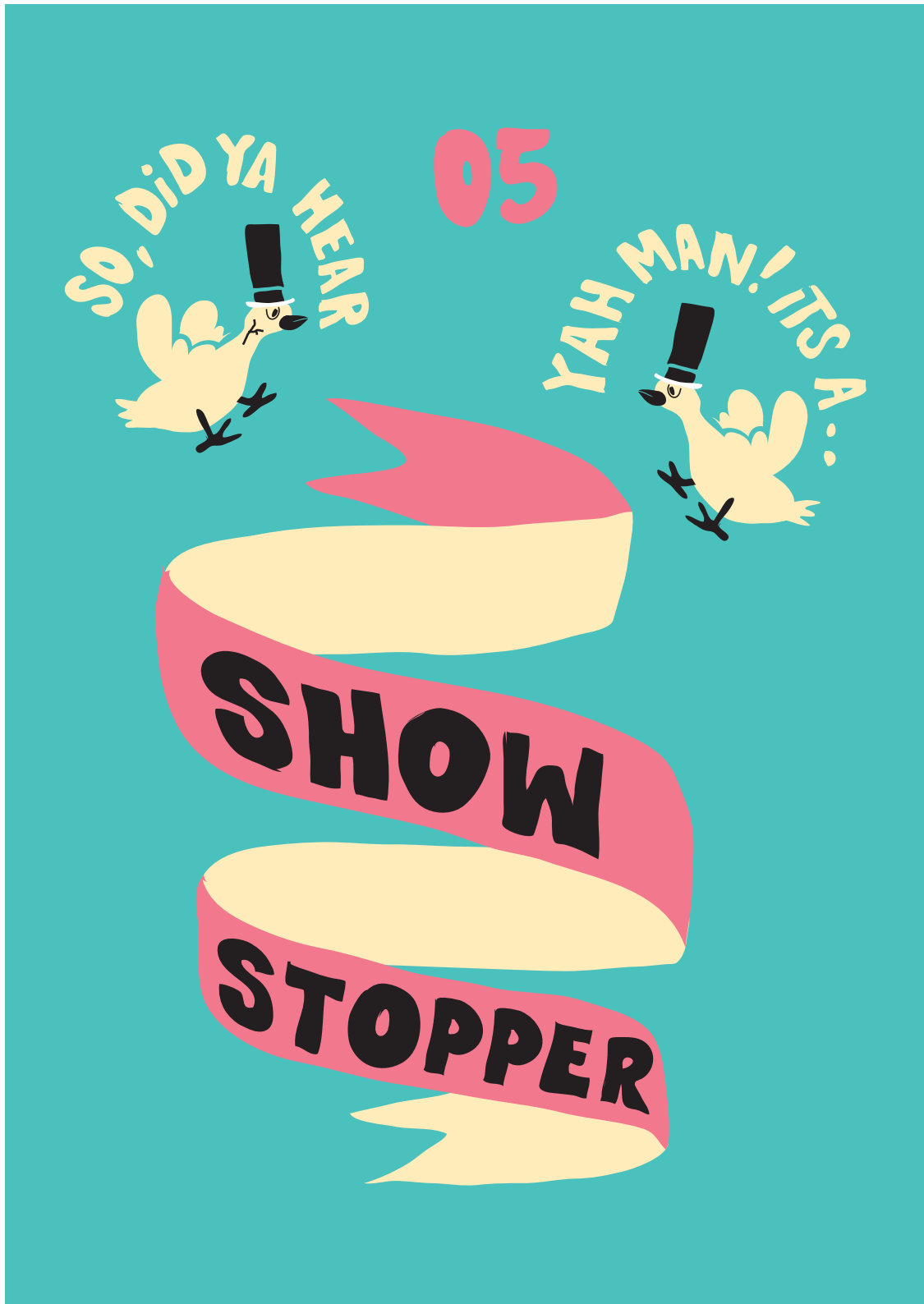



### **LIVEABLE & LOVEABLE**

Battersea Power Station will be a real place for real people to live, work and play, not another dormitory development on London's riverfront.

To be considered 'home' we must make a neighbourhood where there are unparalleled opportunities for people to live life to the full and fulfil their lifetime ambitions.

## INDUSTRIAL MAGIC

Battersea Power Station is London's quintessential industrial landmark, built to last on a heroic scale.

Its rawness and atmosphere are its authenticity and must drive aesthetic decisions throughout the design process, inside and out, from the word go.

Lose this and you lose The Power Station.



08

CULTURE!



CULTURE!  
CULTURE!

**CULTURE,  
CULTURE,  
CULTURE**

By 2020, the name Battersea Power Station will be synonymous with culture, innovation and creativity the world over.

To make this happen, contemporary culture and cutting-edge creatives must be accommodated at every turn and lie at the heart of every single development decision.

It's in its DNA.

## THE GOOD LIFE

At Battersea Power Station, sustainability is a given. It must embrace all that is positive about low energy city living.

Our job is to make it easy for people to change their habits and live more sustainably without compromising their quality of life.





**MAS  
SIVE  
1CON**

**INTIMATE  
PLACE**



**MASSIVE ICON,  
INTIMATE PLACE**

Battersea Power Station must come across as both a massive icon and an intimate place.

The contrast between the two will define its special character and make it memorable.

At one moment monumental and awe-inspiring, at the other browsable and fine grain.

It's in a class of its own.

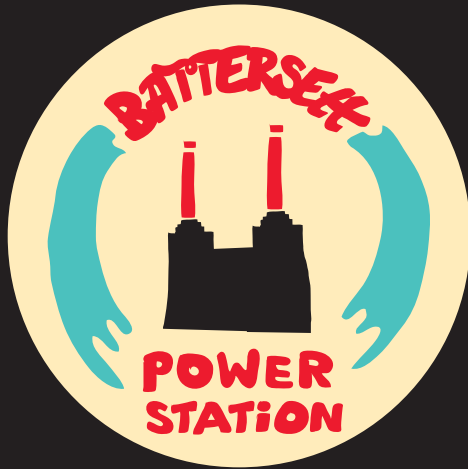

# The Power Station Manifesto is an aid to decision-making, providing a set of values that will guide this remarkable new place into existence over the next 20 years.

## **MANDATE FOR DELIVERY**

There are a myriad of different roles people will play in the making of Battersea Power Station. Day-in and day-out, hundreds and thousands of small (and not so small) decisions will be made that determine the final success of the place. The ten points of the Manifesto are there to guide these personal judgements and ensure the principles inform and affect the development at every level, from bins to buildings, homes to hoardings, milestones to moorings.

The Manifesto has already shaped the Placemaking Strategies set out in the rest of The Placebook, ensuring the creative ideas developed in the eight thematic chapters that follow will help us to deliver on our aspirations. But we're also placing it right at the front of all the consultant briefing documents, to make absolutely sure our architects, landscape designers, engineers, letting agents, sales and marketing teams and PR gurus are all singing from the same hymn sheet.

More than any other aspect of the project, the Manifesto is intended to have longevity. There is no doubt The Power Station masterplan will continue to evolve over time – as all great masterplans do – with each phase bringing its own memorable architecture, inspiring culture, dynamic retail and fantastic leisure concepts. But while all these things rightly remain in creative flux, responding positively to shifting times, new priorities and emerging ideas, we fully expect to stick to our Manifesto and its implications for delivery.

This is because metaphorically speaking, we think the Manifesto is all about 'leaning the ladder against the right wall' – giving ourselves a clear set of principles for achieving our overarching goal – to produce a compelling place for London for the next hundred years.

# making it all add UP

What do you remember when you think about all those great places you've visited?

Great architecture? Stunning landscape? Or the sense of the overall experience?

While a manifesto can influence the big picture – great places are all about fine grain, subtle detail and complex interrelationships and few new developments can match the character and lived-in quality of areas of urban areas that have evolved over time. But this is where innovative Placemaking Strategies can help – designed as they are to increase the vitality and sociability of a new neighbourhood, encourage greater footfall, lengthen dwell times and accelerate the development of a sense of personal attachment.

Placemaking is a relatively recent concept, having only emerged as an approach to development over the last couple of decades. As an idea it has its roots in the late 1960s when urban commentators like Jane Jacobs and William H. Whyte began to voice their criticism of modern architecture and city planning. In their eyes, the shabby but well loved neighbourhoods being torn down in the name of progress offered infinitely richer human experiences than the bland, soulless monocultural projects replacing them.

Their work inspired a greater appreciation of the structure and characteristics of places that grew organically over time – and led to an increased level of research into the factors that make them attractive and liveable.

## THE CHALLENGE OF PLACEMAKING

Today, a great deal of Placemaking research is accepted wisdom – intimate streets and spaces encourage social interaction, mixing land uses within a neighbourhood makes them more animated and supportive of everyday life and varying the sizes, scales and densities of buildings makes for a richer urban experience.

Despite this, creating a place from scratch remains a formidable challenge. One reason is that in the making of urban development, attention is often overwhelmingly focused on the ‘hard’ aspects – the buildings, landscapes, roads and pathways that define the physical environment – usually to the detriment of ‘soft’ aspects such as unique retail and leisure offers, arts and cultural initiatives, community facilities and organisations, social networks, event programmes and estate management.

With legions of development experts required to resolve land procurement, financing, building design, infrastructure and servicing, technical resolution, planning and building regulations, construction logistics and phasing – it’s easy to see how the critical issue of what people will actually experience on completion can become sidelined, or even ignored during the development process.

Although place design (its aesthetic) dominates development thinking it is only one of four constituents that influence a great place experience – there are lots of examples of developments with spectacular architecture that don’t function well as places and just as many mediocre old buildings that do.

Place offer (its content), place management (its operation) and place brand (its identity) are all equally important – but when these issues are considered, it tends to be as an uncoordinated, linear sequence by different specialists.

After the design comes branding (which are frequently unrelated), then content (the highest paying tenants) and finally operation (when estate management is put in place).

Small wonder the whole is rarely more than the sum of the parts.

## PLACEMAKING STRATEGIES

What follows in this Placebook is an approach to disrupting traditional development thinking (NO DEFAULT) – with eight thematic Placemaking Strategies outlining the nature of the Battersea Power Station place experience.

Each chapter (evolving, playing, shopping, working, living, learning, connecting and branding) begins with a short essay, which includes an insight into the strategic thinking of the Placemaking process, that provides a context for the place points that follow. There are 60 of these across the eight themes, whittled down from literally hundreds of ideas and inputs.

Each playful statement offers a small, yet pertinent piece of thinking about the place experience. None are written in stone, but collectively they capture the specific character and mood of what is intended – often the kinds of things you can’t easily show on a set of architectural drawings. It’s fundamental to get these intangible aspects right if Battersea Power Station is to become one of the world’s great places.

The accompanying illustrations are specially commissioned (SYMBOLIC ACTION) from students at the University of the Arts London (CULTURE, CULTURE, CULTURE) to provide each chapter with an intriguing visual identity.

Intended to inspire and focus our agents, consultants, investors and collaborators on the place experience, what follows is quite simply a taste of things to come.

# EVOLVING





# how does **your** garden grow

When we think about making new places, why do we always focus on the finished article?

Phased development is a journey through many places.

*Illustrations: Jung yun Roh*

Cities are amongst the most complex of human inventions – networks of buildings and spaces in constant flux, endlessly adapting to meet the shifting needs of the society.

In the majority of neighbourhoods these changes are slow and incremental, sometimes for better and sometimes for worse, so only the infrequent visitor notices a place gradually ‘on the up’, or in long-term decline.

But massive change, the planned redevelopment or regeneration of large areas of the city, is also slow. The UK planning system and complexity of construction mean large-scale urban projects can frequently take two decades or more from initial sketch to final completion. So although it’s tempting to look at a masterplan and just envisage the finished article at a fixed point in the future – a perfect neighbourhood with a settled community, mature landscapes, thriving bars and cafés, plentiful shopping and a lively cultural scene – it’s important to remember that this isn’t the reality of phased development.

Unfortunately not everything can arrive at once and at the outset it will be a fledgling place – with limited local facilities, immature planting and new neighbours. So in addition to that all singing, all dancing long-term vision, there is also a need for a number of shorter-term visions that guide individual phases or iterations of a project.

In this way, attention is refocused from a singular place 15 years in the future, to a choreographed sequence of places, each with its own defining character, built on the shoulders of the last.

## NATURE LESSON

To reimagine ‘phased development’ in this way it is useful to look beyond the property world for inspiration. In nature, such a process is known as seral progression – the successive ecological stages that see barren landscapes evolve over time into lush forests, providing habitats for abundant life (the final climax community).

In the early days after volcanic eruptions, wildfires or glacial recessions, wind-born germinating bodies of mosses and lichens arrive on bare ground. These pioneer communities can survive harsh conditions with few nutrients and help to manufacture the soil conditions needed for the next wave of plant life. With these come the insects needed for pollination, which provide the food for the small animals and birds that begin to inhabit these areas.

In this way, each successive stage of ecological development paves the way for the next, bare ground becomes grassland, grassland gives way to shrubs, shrubs to woodland and forest – more and more diverse landscape environments that support larger and more demanding forms of life.

## STAGED PLACEMAKING

In light of this, it’s more useful to think of phased development as ‘Staged Placemaking’, which suggests a process more akin to seral progression – the creation of successive habitats, places people can live, work, play, shop, learn and connect with one another. This is a useful strategy because, traditionally, ‘phasing’ carries few design connotations and is often driven by the logic of construction and financial viabilities. Instead, architects and other design professionals need to develop subtle approaches to the shifting nature of place and just as in nature where certain plants or animals only arrive when the conditions are right, create stages of development that embrace the changing nature of their target market.

All large-scale projects are of course different and their opportunities and constraints will result in unique rhythms of Staged Placemaking. At Battersea Power Station, five clear stages have been identified that will see the site shift in character from industrial dereliction to global place brand, as homes and amenities increase, landscapes develop and the project appeals to different profiles of purchaser and tenant:

## MEANWHILE STAGES

Although a well-loved icon on the London skyline, few people know how to get to Battersea Power Station and fewer still have walked around Gilbert Scott’s masterpiece. Locked behind hoardings for over 30 years, the site is for the most part devoid of life.

With several years until the first residents inhabit the site, the task of the meanwhile stage is animation. People must know the project is happening and begin to visit the site on a habitual basis, for work, for play or just to enjoy the dramatic choreography of construction. Temporary and dramatic, the meanwhile stage should increase anticipation, build advocacy and sow the seeds for the first permanent community.



## **PIONEER STAGE**

Studies of consumer product cycles single out the importance of ‘innovators’ and ‘early adopters’ in the success of new technologies. Those special early individuals, with a hunger for newness and an eye for the next big thing, will be the first to inhabit The Power Station project. It is their creative spirit and energy that will be the defining characteristic of the Pioneer stage, which is being designed to appeal to their desire for something different from the norm.

## **EMERGING STAGE**

With the opening of The Power Station, the project will gain an iconic centrepiece and become a new destination for London – generating thousands of column inches in the printed press, travel guides and across the web, all around the world.

Visits to the site will become more habitual – well worth the effort, for its unique sense of awe and its clear difference from the rest of the capital. The ‘early majority’ of consumers are intrigued, drawn to the development as somewhere to live and to work – it’s not the final place, but they can see it for what it is – and that it is exciting to be a part of.

## **ESTABLISHED STAGE**

The London Underground station opens and The Power Station is a truly networked place – it’s at the west end of the West End and a short trip to the City. It’s not just a spectacular residential development by the River Thames, it’s an entire neighbourhood or city quarter with education, health, community facilities, a unique retail offer, remarkable office space and renowned cultural venues, bars and restaurants. It’s the moment the ‘late majority’ move in as residents and retail/office tenants – they knew all along The Power Station was something special, but it is only now when most things are in place they feel able to relocate.

## **MATURE STAGE**

The final phases are completed, Grade A commercial office space, the final tranche of homes, another hotel, a few additional facilities – but most importantly construction – physical change – is over. For some, maybe older people, possibly long established and traditionally-minded companies, it is this finality that is attractive, when a project has proved itself a success. These ‘late adopters’ know that having waited so long, prices will be at a premium, but then there is comfort in this, knowing it represents a good investment for the future – reassuringly established.



# Strategic thinking: Evolving

## CURATORSHIP

The daily influx and exodus of people is the reality for most city centres, where for large tracts of time the place is eerily empty.

At The Power Station we are looking to balance activity over the week and across the day, to ensure that as one group heads home, another cluster shows up.

### LEISURE AND TIME: WEEKDAYS

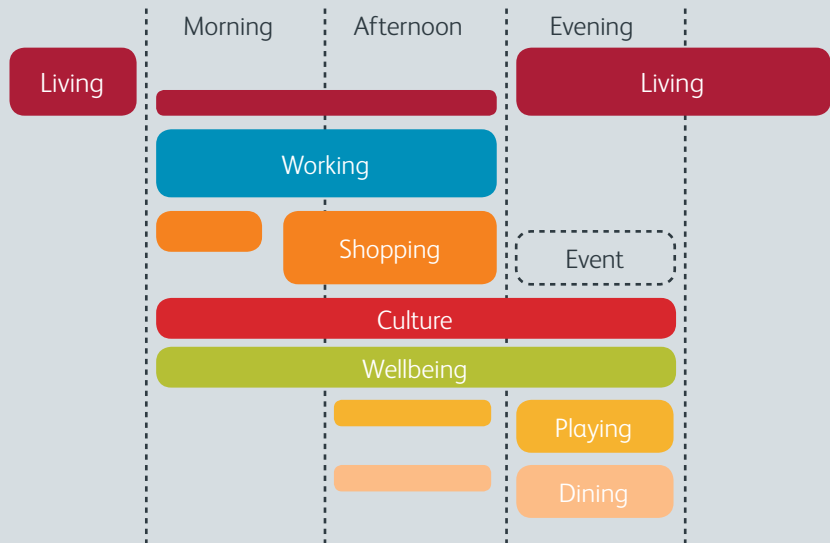

### LEISURE AND TIME: WEEKENDS

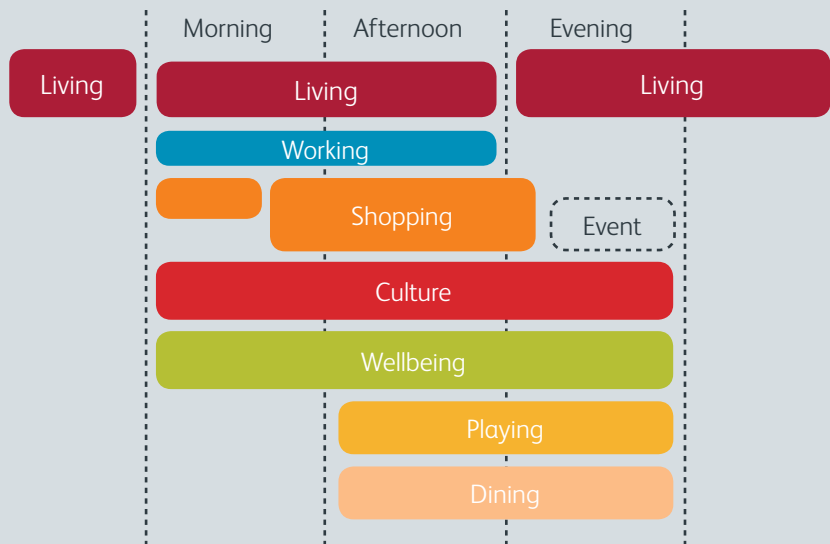

The character of The Power Station in its mature stage will undoubtedly be different to the initial stages. It is possible some of the early pioneers will have moved on, ready for a clean slate, a fresh challenge – more flux. The challenge of the mature stage is not ‘maintaining’ but balancing and refreshing – managing the place in a way that ensures the vibrancy and creativity of the early phases remains and is not snuffed out in the manner of so many areas entering late gentrification.

Staged Placemaking is a subtle art that seeks the highest returns for a site, by focusing on what it takes to make somewhere special every step of the way.

At The Power Station this approach is possible because the development team will maintain control of the site in the long term.

For this to work well, in the early stages the developer needs to act with an unusual degree of flexibility – giving away space to people with creative energy, offering low rents to quirky shops so they can sit alongside luxury brands, putting on spectacular free events, providing temporary facilities in early phases.

It might seem counter-intuitive to ignore the bottom line, but the reality is great places bring great returns in the long run.

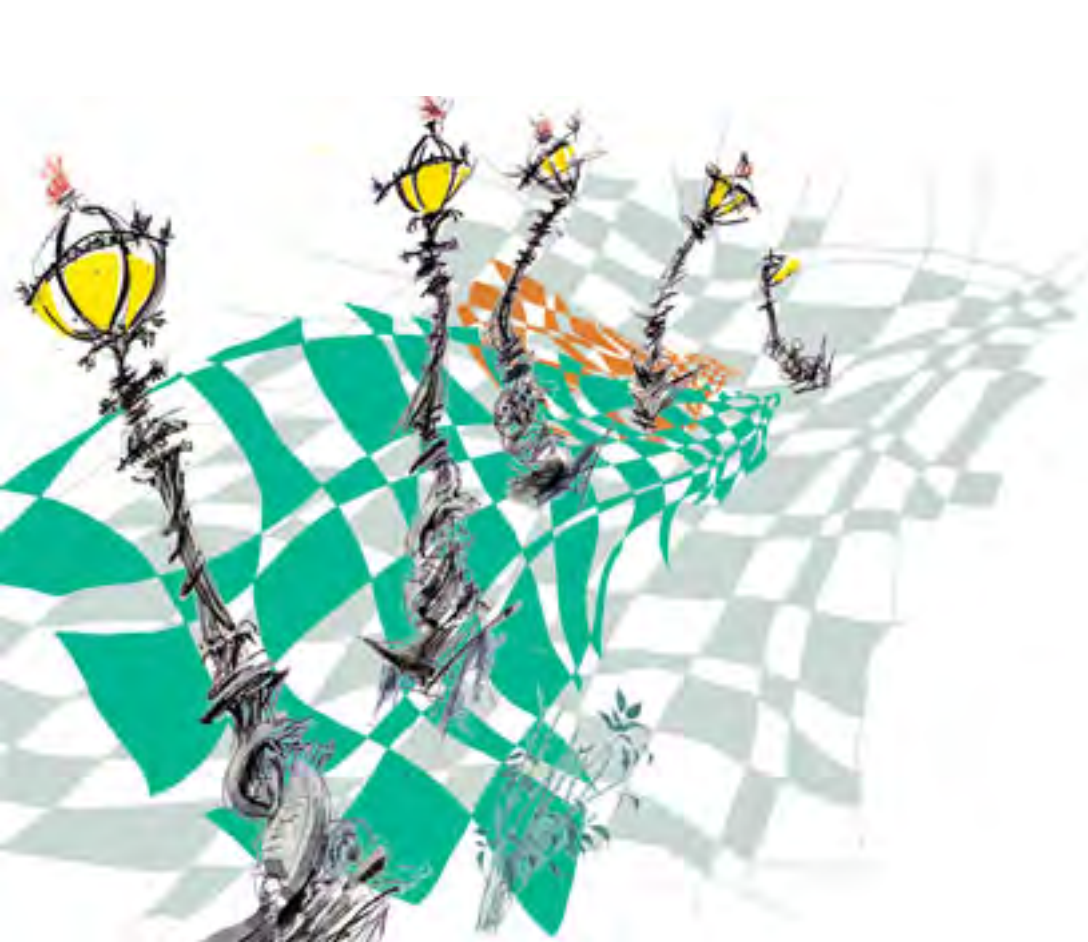

*The time has come to do  
something in the here and now.*



**FACT:**

Nearly 75% of meanwhile projects in the more traditional sense of meanwhile uses are in vacant retail units, while other types of spaces (office, housing, pubs, car showrooms and building sites) are increasingly being brought into use.

## 01. Meanwhile

Who would have thought that over eight public consultation exhibitions more than 15,000 people would turn up to see what we have in store for Battersea?

That once we started taking bookings for one-off events on-site, the phone would never stop ringing with people dying to host/film/broadcast their thing at Battersea? It's got more cachet than we bargained for and it's been a happy problem for us ever since.

Building on this momentum, we've decided to get people acquainted with this new urban destination as soon as possible. Not just through magnificent ticketed events, like the Freeze Festival and Red Bull X-Fighters, but also as a part of their everyday life. So everyone is welcome to come over to our place, bring their children and picnics and hang out in the temporary pocket park we've created. It's about kicking back, enjoying the river and views of central London, maybe looking around the Chelsea Fringe Festival, or for those who can't sit still, taking a class in Move – our pop-up gym.

We want people to wander round parts of The Power Station and imagine what it'll be like to live, work and play here in just a couple of years' time. Hopefully, they'll go home full of stories and ideas to tell their friends. Then they too can come down for a day, or perhaps check out The Power Station webcam to see what's happening for themselves.

These so-called 'meanwhile' events – which help people get used to coming down to The Power Station – will be our best way of getting everyone interested while the rest of it rolls into action. Because we can put out all the fancy advertising and marketing materials we want, but unless people have a first-hand taste of things to come, unless they feel they're part of something from the start and unless we get crowds of people coming to the site, Battersea Power Station's connections to London as a whole won't amount to much.

And we wouldn't want that.



## 02. Green shoots

There is an ancient Chinese proverb that goes something like this:

*If you wish to be happy for a day, get drunk;  
If you wish to be happy for a month, get married;  
If you wish to be happy for life, make a garden.*

Like gardens, great places can take a lifetime to evolve and mature. Few are created from scratch and most are carefully planned, nurtured and tended over the years, until they blossom. Although The Power Station is a well loved landmark on the London skyline, we need to start planting the seeds for it to continue to stay that way.

Our nursery concept is a key component of the ancillary aspects of Phase 1. Physically, temporary landscapes will help create a green and friendly atmosphere and later the same planting may be reused elsewhere on the site. We will bring Battersea Power Station back to life and the natural landscape will play a critical role in this transformative process.

If we start early, we can ‘hothouse’ The Power Station as a place where things spring to life by literally growing things on-site. That’s even before we get the first buildings open. In the early days, we will get the site up and running with our plant nursery, which will be able to contribute to our series of ‘meanwhile uses’ – a canopy of trees, a temporary pond, gardens to rival the very best the UK has to offer or an art installation that sits as one with nature – will help to cultivate our site.

Large or small, complex or simple, a temporary and evolving natural landscape will play a critical role in evolving the site into its future as a mixed-use neighbourhood.



**FACT:**

An RHS survey found that 73% of respondents found gardening to be a good way of unwinding from the pressures of work.



*Till the soil for  
the years to come.*



## 03. Grass roots

Everyone wants to fulfil their true potential in life. They want to experience that feeling that comes from starting something from scratch, something that really taps into what others are looking for and takes on a life of its own, evolving within a community and inspiring others.

Maybe that sounds a tad idealistic, but all across London there are signs that people are waking up to their unfulfilled dreams, sometimes out of a lack of alternatives, sometimes because the right opportunity presented itself.

The little vacant shop unit that said 'let me' to a would-be wholefood stockist and so they did. The offer of a studio in a graduate centre that was the start of everything for a graphic artist. The chance encounter with a neighbour at a street party where a new PR business idea took root.

Battersea is a site of extreme potential right now, with acres of vacant space, ripe with untold opportunities. We're setting aside some spaces for people with really good ideas, who are ready to put these ideas into action. We want to explore what happens when you create the sort of place where grass roots activities are the norm. What if we help people to grow ideas, through an innovative scheme of rewards and incentives, which connects people to shared resources and good advice?

That way, we might find that in ten years' time, Battersea has the highest number of innovative collectives, creative mavericks and entrepreneurs per capita of any other part of London, with some of the most enlightened and successful common interest groups in the UK choosing to locate here. That would be a real marker of success.





*What if they could make  
my dreams a reality?*

**FACT:**

Small and medium-sized enterprises account for more than half of UK employment and turnover.

*Arrive at opening  
time for the best seat.*

## 04. Pioneer

Are you going to be one of those people who buys into The Power Station early – really early – before everyone else wakes up to the excitement of living not only next to the Thames but also one of the world’s most remarkable industrial buildings?

While we talk of pioneers, we don’t mean it will literally be like the Wild West! Of course, Battersea’s early adopters will have all the benefits of food and water, but the place will still be in a state of flux and will be in the early stages of its formation as part of a city for some time.

Our task is to ensure that even from the pioneer days, Battersea Power Station makes sense as a place, not just physically, in terms of buildings and spaces and how they connect through to the local area, but also as an emerging new neighbourhood, with all the shops and facilities it needs to function properly.

This means balancing the permanent uses with some temporary facilities. These could be housed in existing buildings and eventually move elsewhere, or set up firstly in a remarkable temporary structure and then graduate to something bigger and better later on. Together, these uses will work hand in hand with the ever-changing natural landscape of the site. This way, the flux is something positive, ensuring that each stage has its own particular identity before it evolves into the next one.

So, if you’re one of our intrepid pioneers, you might just strike gold in this corner of south west London.

**FACT:**

The city of San Francisco had 459 inhabitants in the latter part of June 1847; by the close of 1849, following the 'discovery' of gold, between 25,000 and 30,000 people were living in the city.





*Abuzz with activity around the clock:*

**FACT:**

The UK's night time economy is worth £66 billion and employs over 1.3 million people.

## 05. Night & day

Are you an early bird or a night owl? We love the idea that the city never sleeps. Even for those usually in bed before midnight: staying out really, really late and enjoying yourself in bars, cafés and clubs into the small hours can make us feel carefree and alive.

Then again, one person's late night is someone else's early morning, as the day's bread is coming out of hot ovens at 4am just as wholesale markets, like our neighbour New Covent Garden, take delivery of the freshest fruit and vegetables to go to shops and restaurants all over the capital.

Night time is when the city often looks its best – light spilling out of doorways onto a wet pavement – it adds another dimension to the urban experience. Daytime has its moments too: early morning when the newsagent sells its first paper, the sunlight glancing across the rooftops. Or when there's been a fresh snowfall overnight and the city wakes up, white and strangely hushed the next day.

We want Battersea to feel special, come rain or shine. Summer or winter, night or day – somewhere that makes you notice your surroundings and never feels deserted or unsafe.

It's more than that – we want it to offer the guarantee of a good time, whenever people choose to come.

A fabulous rotating programme of events that's constantly changing, sometimes themed and seasonal, sometimes curated by a special guest we've invited over from New York, sometimes celebrating in a more local way, but always buzzing with opportunities to interact and have fun.

Of course we've got to manage the noise levels so the residents aren't inconvenienced by the late night revellers, but we'll do this by separating land uses and planning the spaces well. Well, maybe on New Year's Eve it'll be a bit hard to contain the excitement.

But that's why you moved here.

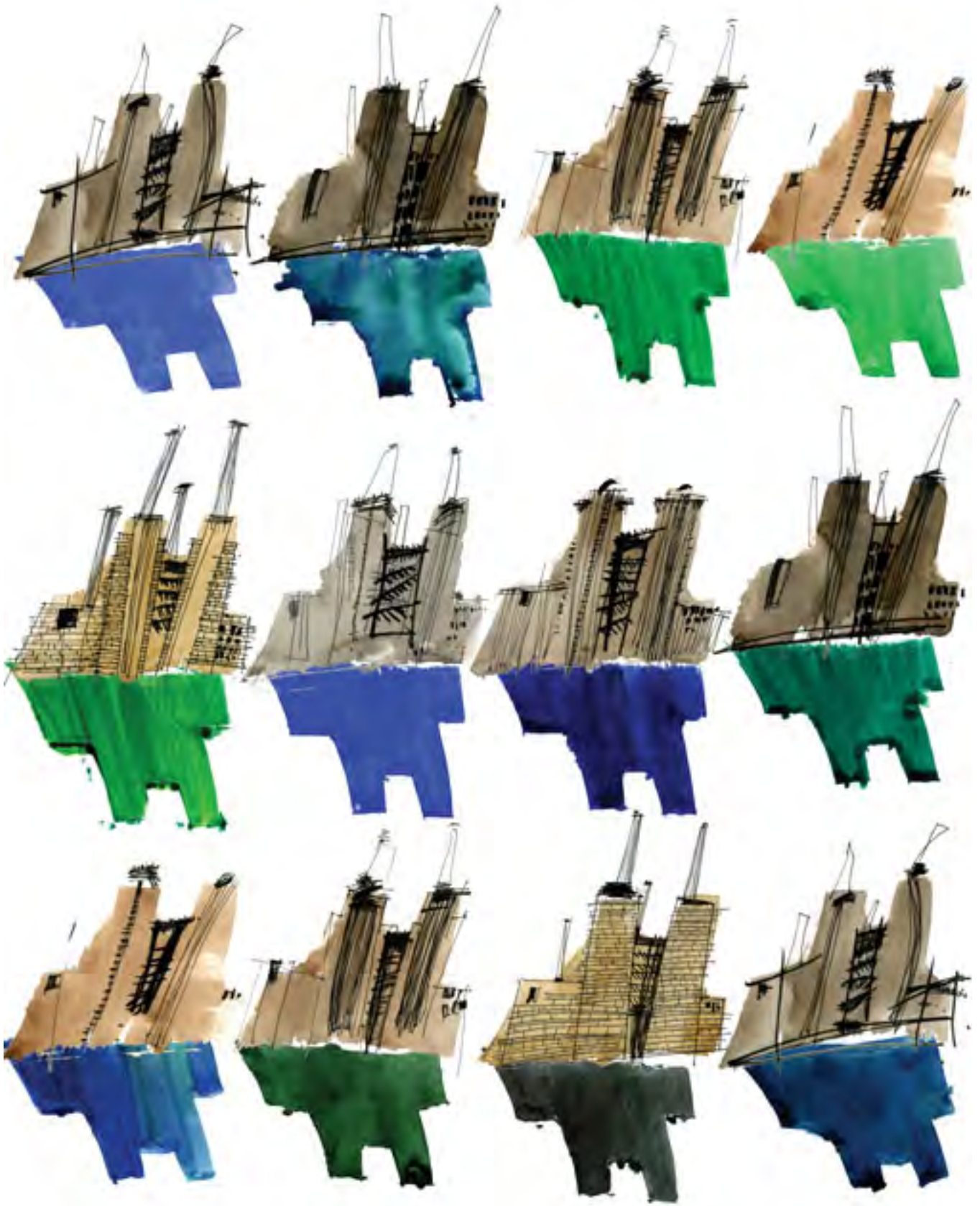

## 06. Place director

Art directors, film directors, festival directors – every large scale creative endeavour has a creative and visionary guiding hand.

That special somebody driving the overall vision, defining the experience, envisioning the behind-the-scenes logistics and finding the talent to make the final product something truly special.

But where are all the place directors?

Looking around London, it's obvious there are not nearly enough of those talented individuals who know how to turn a group of interesting buildings and spaces into a living, breathing place – full of the joys of life and with a few surprises thrown in for good measure.

Our place director will have a master's degree in authenticity, or at least they would if such a thing existed. Instead, we'll settle for someone that has a passion for real urban experiences and a healthy disdain for corporate precincts and disneyfication.

Using the Manifesto as a roadmap, they'll be orchestrating Battersea Power Station into the capital's most memorable day out, with an intoxicating blend of bespoke shopping, audacious entertainment and epicurean delight. Who knows, they might even throw caution to the wind and invite some creative maverick in for a season as guest place director.

So that's the fun bit. But behind the scenes they'll also be working hard on everyday operations and customer care, making security, deliveries, cleaning and maintenance next to invisible and everything have a welcoming, laidback and easygoing feel.

So that's the job description done then. Anyone interested?

# PLAYING

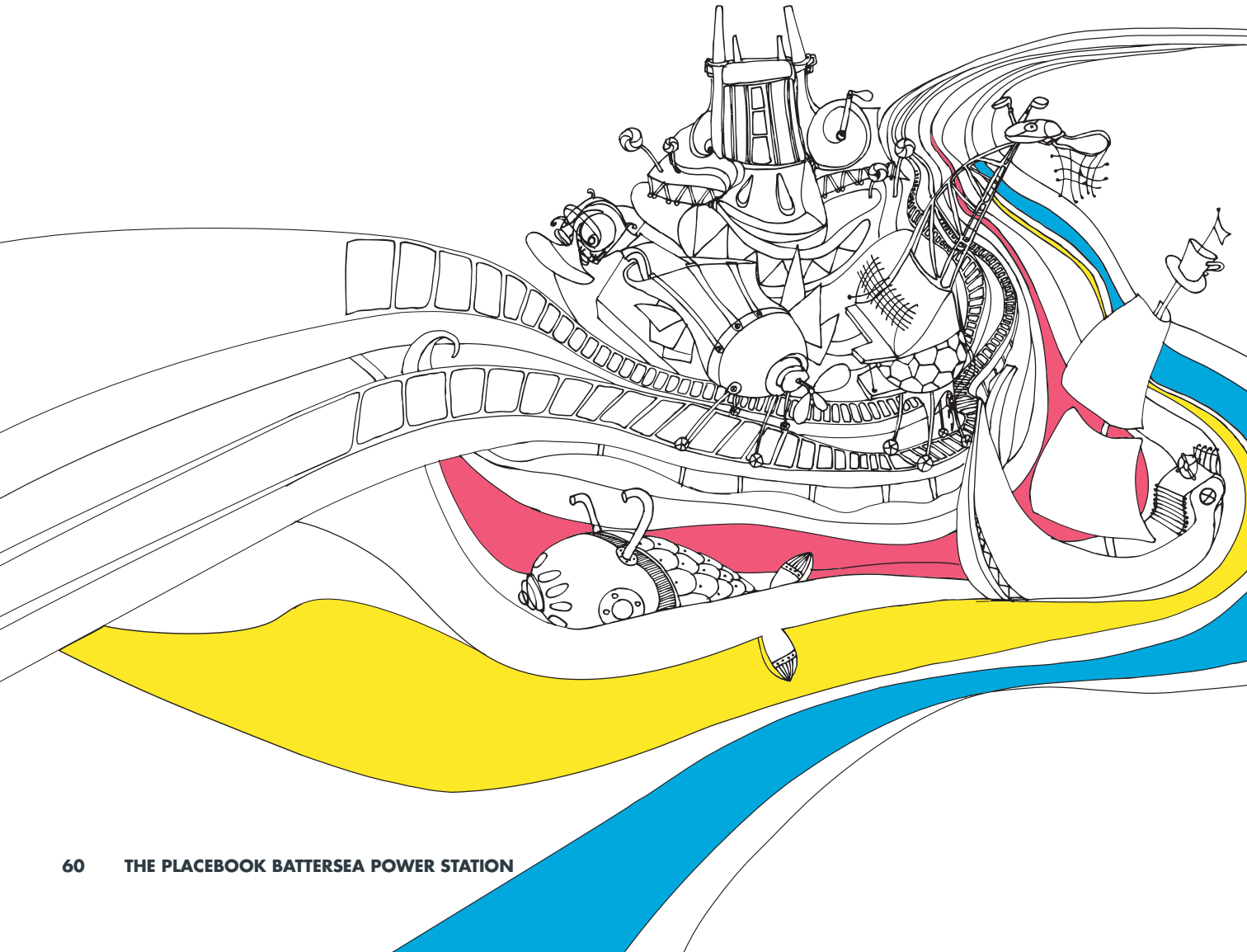



# easy<sup>like</sup> Sunday morning



Playing is not just for children; it addresses a fundamental human need, providing a means of rejuvenating the mind, body and spirit and rebalancing people's lives away from the demands of home and the workplace.

*Illustrations: Miglena Minkova*

Because everyone is different, personal leisure time can take many forms and can be focused around socialisation, creativity, intellectual stimulation, personal growth, physical activity, or simply relaxation. Creating a compelling leisure offer for Battersea Power Station requires an understanding of the activities and places people engage with during their 'down time' and what people like and expect from their leisure activities and leisure spaces.

## **HOME: THE COCOON**

Half a century ago, leisure options were much more limited, creating a mass market for activities like cinema-going which at its peak in 1946 had attendance of over 1.6 million people. The advent of television, which was both novel and convenient, had a fundamental impact on leisure habits, shifting the focus from 'going out' to 'staying in'. Technologies such as cable and satellite TV, streaming services, the video, DVD and Blu-ray players and computer gaming consoles have since further increased the range of leisure options available in the home and, perhaps more importantly, removed the idea of 'programmed time' (the fixed menu of the radio and TV), freeing people to watch what they want, when they want.

This retreat into the home was termed ‘cocooning’ by trend consultant Faith Popcorn in the 1990s, reflecting the fact that this represented a privatisation of leisure time.

Since then, the internet has added a further dimension to home-based leisure options, although developments such as social networking and networked game play (Xbox, PlayStation, Wii) now mean these are not necessarily solitary activities. Such shifts require a response in the design of domestic interiors at The Power Station, but the emergence of Wi-Fi and sophisticated mobile devices such as smartphones and tablet computers, mean these leisure activities are no longer constrained to particular spaces in the home and may now be enjoyed outdoors, or even while commuting.

### **NEIGHBOURHOOD: THE THIRD PLACE**

In his book *The Great Good Place*, sociologist Ray Oldenburg reflects on the increased privatisation of leisure time in the home and outlines the importance of what he calls ‘third places’. These are defined as informal gathering places – the pubs, cafés, bars, coffeehouses, bookstores, libraries, community halls, parks and gardens where local people can meet in their leisure time. Oldenburg sees these as key areas of socialisation and providing people with an important alternative to the demands of the home (‘first place’) and the workplace (‘second place’).

Although third places are essentially a neighbourhood leisure offer where local communities enjoy each other’s company, the sense of authenticity they exude make them highly attractive destinations for visitors.

Third places have a regular clientele, a relaxed playful mood and although radically different to the domestic sphere, they offer an informality and psychological comfort that mark them out as a ‘home from home’. To function well, Oldenburg suggests they must be free or inexpensive to enter and allow for the purchase of food and drink. Third places also need to be highly accessible, located within residential, or mixed-use neighbourhoods where they can be used habitually by local people. Welcoming and comfortable, third places are somewhere people should expect to find old and new friends and where conversation flows easily.

Although third places are essentially a neighbourhood leisure offer where local communities enjoy each other’s company, the sense of authenticity they exude make them highly attractive destinations for visitors and it is often these locally distinctive establishments that are sought out and published in urban lifestyle magazines and city guides.

## DESTINATION: THE EXPERIENCE

To be a successful place, The Power Station will need to compete at a city scale and act as a leisure destination for Londoners and visitors from outside of the capital. What audiences are now looking for has transformed radically over the last decade, leading to the emergence of what theorists Joseph Pine and James Gilmore have called the 'Experience Economy'.

This describes the comparatively recent shift in consumer focus away from the purchasing of desirable 'things' and towards more meaningful 'experiences' – where an event or activity becomes the 'product' and there is a transformational dimension. In many ways this counteracts tendencies towards 'cocooning', with destination based leisure 'experiences' providing people with more of an impetus to spend leisure time outside the home.

The impacts of the Experience Economy on the leisure industry can be observed in a number of areas:

## SPECTACLE

Over the last ten years there has been a collapse in the sales of music CDs, yet this has been accompanied by a huge growth in demand for live performance. This has led to more spectacular productions or unique/intimate performances by big artists that have driven higher ticket prices and the emergence of special VIP concert packages. In a similar way, the film industry has had to respond to the threat of large flatscreen TV's and home theatre systems by increasing the spectacle, with IMAX and 3D films, immersive cinema, luxurious settings and high quality sound.

## PERSONAL DEVELOPMENT

The term 'self-actualisation' is often used to describe a category of individuals seeking to transcend the everyday and create a more meaningful life. Not content with passive consumption of mainstream media (TV, film, theatre) these people are interested in 'transformational' leisure experiences, driving demand for evening classes (music, languages, craft), workshops, lectures, talks, book clubs, appreciation of art and culture and increased connoisseurship of food and drink.

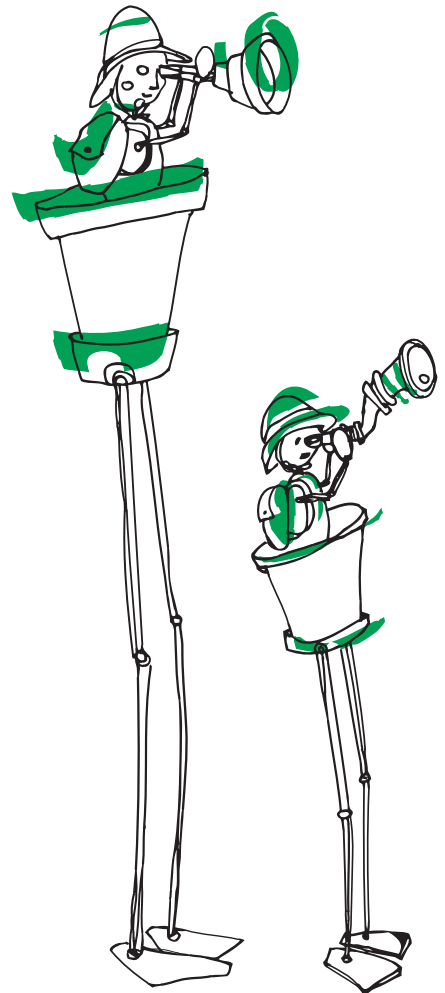

# Strategic thinking: Playing

## LEISURE MAP

Although delivered by individual leisure operators, The Power Station leisure offer will be centrally curated.

A series of thematic areas have been identified that can be used to provide the basis for planning the different concessions in terms of size, type, spend profile, location and associated retail, food and beverage offers and education opportunities.

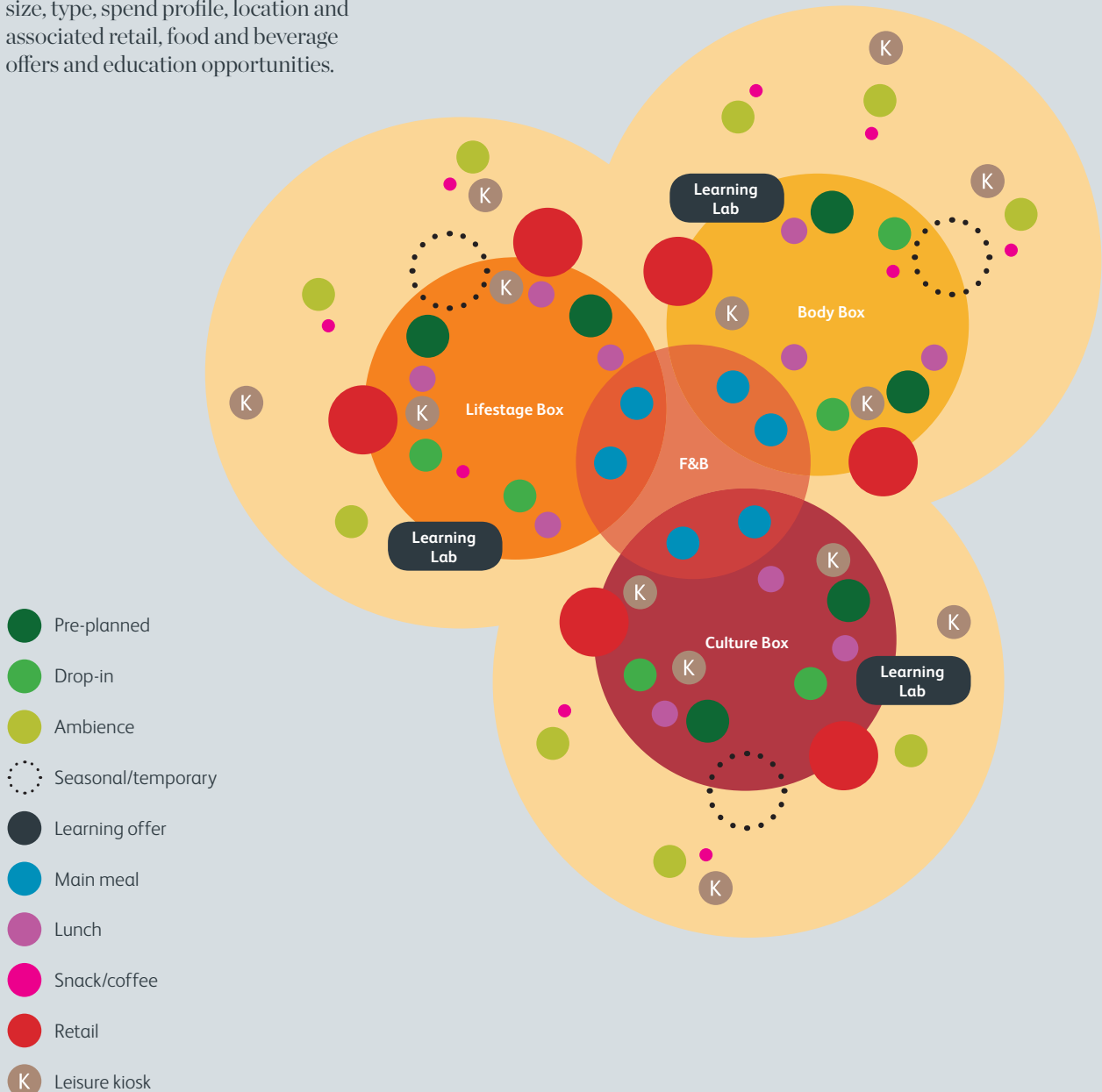

## **HEALTH & WELLBEING**

20 or 30 years ago, health foods, yoga, and body treatments would've been viewed as the pursuits of a small and highly 'alternative' audience. But with the increasing pressures of contemporary life, issues of personal health and mental/spiritual wellbeing have moved centrestage and triggered huge demand for gym memberships, personal trainers, relaxation classes, healing and spa/beauty treatments.

## **ONE-OFF**

Nothing appears to drive demand for leisure more than the offer of a unique experience, or one available for a short period of time. Building on the success of Glastonbury, the number of music festivals have increased rapidly in recent years, as have temporary cultural events taking place in unusual settings such as abandoned buildings, museum galleries and railway stations. These 'once-in-a-lifetime' events have a scarcity value and come imbued not only with a strong sense of authenticity, but also exclusivity.

Turning Battersea Power Station into a new leisure destination demands a sophisticated and unique approach. London's West End offers a comprehensive, if somewhat daunting, array of leisure options spread over a large area, with a great night out usually due to either judicious planning or pot luck. On the other hand, planned environments such as the 'leisure-boxes' found in suburban locations offer great convenience (car parking, proximity of activities) but tend to provide generic and unmemorable experiences, in terms of culture, shopping and eating out.

The compact geography of The Power Station, together with the architectural quality of the environment, mean it is possible to deliver all the excitement and drama of the West End but with co-locational advantages of the 'leisure-box'. But more than that, there is scope to create a unique blend of domestic (cocoon), neighbourhood (third space) and destination (experience) forms of activity, that allow people's lives to flow from one space of encounter into the next, as well as remain separate and distinct when they need them to be.

Real places are where lasting friendships develop and thrive, in the kinds of spaces outlined on the next few pages. It will be vital to conceive of Battersea as an overlapping of different leisure spaces and experiences, of home life and public life, all of which evolve slowly through time and place.

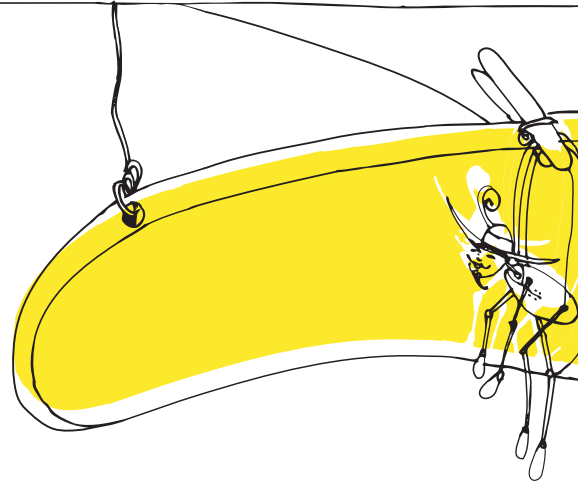

## 07. Guess what I saw

One of the great joys of living in a city like London is having access to truly world-class cultural events. Opera houses, art galleries, museums, concert halls and theatres – the capital has them in abundance. In fact, there is so much to do, you could spend the whole week at home just reading Time Out magazine.

Amongst all this, there are some events that transcend the idea of simply going out for the evening. They are the once-in-a-lifetime performances, parades and extravaganzas that really cause a stir. These have the power to become mass talking points and tend to live on in people's memories for years to come.

The highlight of one Red Nose Day in the UK saw Blue Peter presenter Helen Skelton's 150m walk on a highwire around The Power Station's chimneys – the first person to ever complete such a feat. Although completed in just 11 minutes, her amazing accomplishment will live on for years to come as one of The Power Station's most memorable events.

And it's exactly this kind of thing we'd like to be staging in future – idiosyncratic, thrilling, catch-it-while-you-can experiences. We're up for first run shows, spectacular outdoor performances, Secret Cinema (shhh!), interactive artworks, experiential theatre, circuses, cabarets and film premieres.

In any event, meaningful and memorable for all to enjoy. You saw it here first.



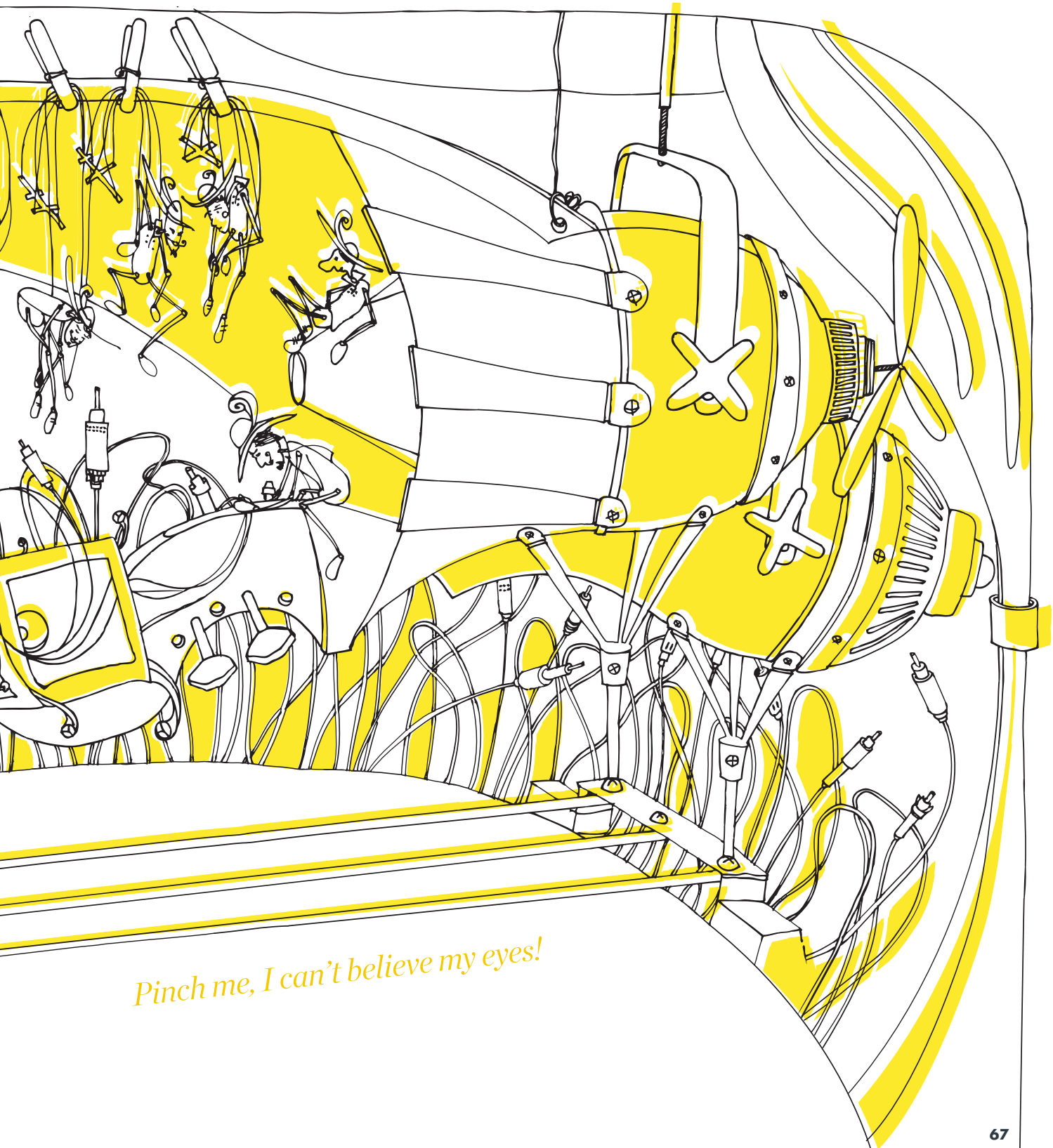

*Pinch me, I can't believe my eyes!*

## 08. Real festivals

There are ‘festivals’ and then there are real festivals – it’s fairly easy to spot the difference. ‘Festivals’ are the ones with a bit of bunting, a burger van, a tired bouncy castle, a strange collection of stalls and a group of people wondering what it is all about and why they ever bothered to come.

Real festivals are completely different. They have true purpose behind the celebrations and involve the actual participation of a large number of those attending the event itself. In short, real festivals are organised by enthusiasts for enthusiasts. They’re intimate, non-corporate and fan-friendly.

The Thames Festival, for instance, goes to great lengths to involve communities across London in all manner of activities prior to the big day. So when you go along on the day, it’s not just something for the tourists, it’s just as much for local people to come down to watch their family members take part. That’s what keeps it real.

In time, Battersea Power Station will be home to a whole range of meaningful festivals. Some will extend and revitalise existing revelry in the capital – like Freeze, Love London, the London Festival of Architecture, Open Gardens, Wireless, Taste London or Lollibop Festival. Some will be about the re-enchantment of traditional seasonal festivities like Christmas, Guy Fawkes Night or May Day.

Other festivals will be street parties thrown by and for the local residents, because that’s when we’ll know we’ve succeeded in nurturing a real community.

Who knows what weird and wonderful things we’ll see! A sonar festival of sound and light? A riverside cookout? A latina fiesta? A bestival?

Rest assured, we’ll be rooting out all those who feel they have something to celebrate but nowhere to do it.

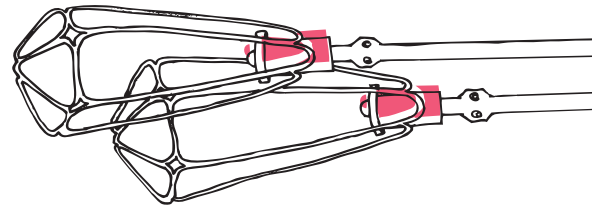



**FACT:**

More than a million people attend Notting Hill Carnival every year, London Film Festival attracts more than 100,000 film goers and 50,000 go to the Great British Beer Festival.

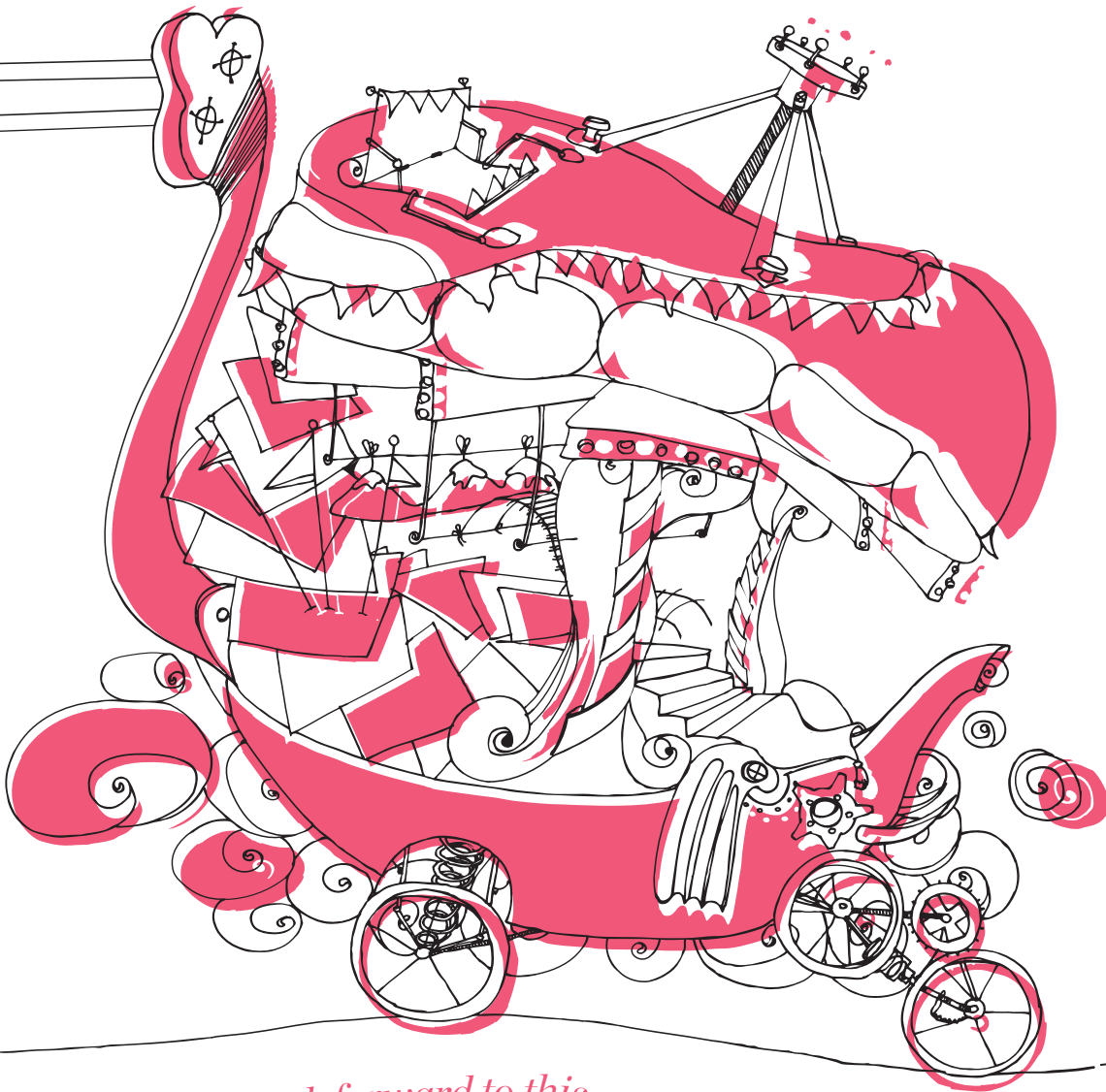

*I look forward to this each and every year.*

**FACT:**

Around 70% of adults in the UK want more time to play with their children and 80% agree that outdoor play helps foster a community spirit between families.



*A place  
where your  
imagination can run wild.*

## 09. Childsplay

What would the world be like if rather than prohibiting everything, we invited people to get on with enjoying themselves?

The rules seem worst for kids of course; not only are the simple pleasures in life forbidden (NO BALL GAMES!), grown-ups don't want them to move around (SKATEBOARDING PROHIBITED!), or even stay still (NO LOITERING!). They just can't win.

It's a complicated issue though – younger children can't play outdoors without permission and this comes less easily than in the past. One recent study found that an 8 year old in 1920 was allowed the freedom to roam up to 10km from home, but by 2010 his great grandchild was limited to a 300m radius. In London today, it's probably about 30m.

So what can we do to help? We can start by making playspace that's inherently safe and yet confounds expectation – a place every parent will want to bring their child and every child will want to be. That's not swings and slides – its a place with genuine opportunities for improvisation and creativity – the ability to move things around, build a den, make a sculpture, even get muddy or wet.

At The Power Station, parents won't care about how long their children will want to stay because we'll be giving them what they want too – a café, Wi-Fi, comfortable seating, a newspaper stand, a view of the river, toilets and baby changing facilities, so they can supervise in comfort. And if the grown-ups are happy, you bet your life the kids will be, because it's all about permission.

And for the older kids? Well, it can't be lame can it? It needs to be their idea of a good time not some dumb grown-up. Climbing anyone? Basketball? Skateboarding? Oh and one last thing, how about avoiding uniformed security guards (DON'T DO THAT!) and employ some inspiring 'play rangers' (DO THIS!).



## 10. Free time

For some reason, we don't have a specific word for taking it easy and relaxing with our friends and family without a big plan.

Across the Atlantic they call it 'hanging out' of course, but over here that conjures up images of bored teenagers sitting around with nothing to do.

But just because we don't have a proper name for it doesn't stop us from finding the nearest patch of grass and kicking off our shoes on a summer's day. Reading, sunbathing, playing games with our children, picnicking, or just watching the world go by – these are but a few of the pleasures in life that can be enjoyed once the weather picks up.

This is exactly the laid-back, easy going feel we want to nurture in The Power Station Park. But to get people to slow down and make themselves at home will need acts of generosity on our part.

We need to get the furniture just right, with benches and deckchairs, places to lay out your home-made food and who knows – maybe even an informal barbecue point or two.

We also need invisible management, that deals with the boring things like maintenance, litter collection and cleaning and an informal approach to safety and security that dispenses with those petty rules that spoil the fun.

Whether you live or work at The Power Station, or are there to shop or take in some culture, we know there should be things you can just stop by and watch – no charge – like some soulful music or a puppet show. All this should act as a reminder that when it comes to leisure time, the best things in life can still be free.

*Let me sit back and watch the world go by.*

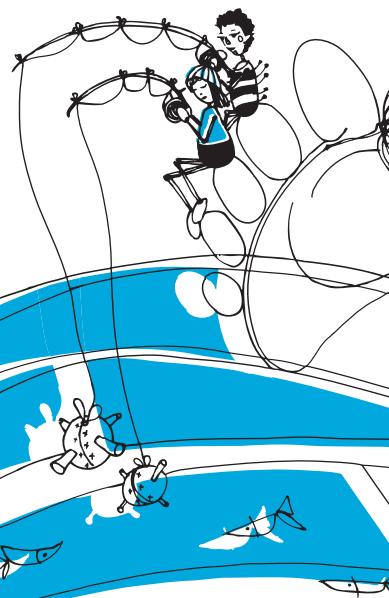

**FACT:**

The UK household spends on average over £60 per week on recreation and culture.



**FACT:**

A recent Great Britain Day Visits Survey found that GB residents are reported to take 1.7 billion tourism day trips per year and spend around £57 billion on these trips.

*Where did the time go?*

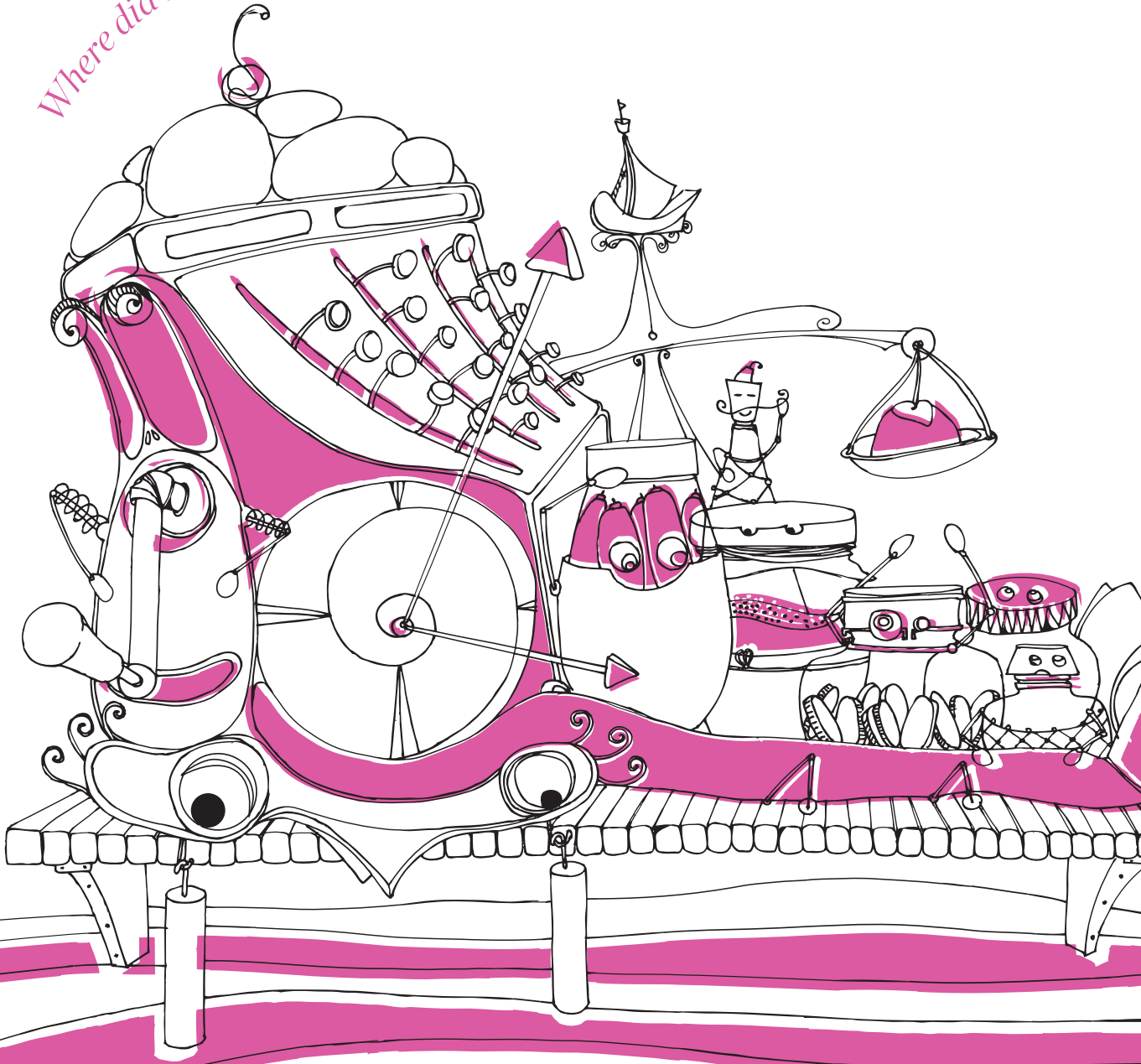

## 11. Grand day out

Ever had one of those days, when you go into town with half a plan and before you know it the whole day has flown by? Where one delightful thing leads to another and you were left with the warm glow of life well lived?

When we first started thinking about leisure time at The Power Station, we asked people in the street what would make up their perfect day. Now, you might think, given *carte blanche*, that it would involve all manner of swanky meals, big ticket events and limousines home. But nothing could be further from the truth and almost every one said the same thing.

They liked a low key start to the day – with maybe a bit of exercise first thing – but a lazy breakfast with loved ones was almost mandatory. In the afternoon it was all about browsing – maybe a visit to a gallery or a market, but just strolling about and enjoying urban life. And in the evening? The people we asked agreed on a winning formula that included a bite to eat, a trip to the cinema or theatre, or socialising with friends over drinks. So there you have it – the crowdsourced recipe for the perfect day.

How often does this happen?

Most of us would say not nearly often enough. But more to the point, where could it happen? You see London can deliver all these experiences, but it often means travelling to several different parts of the city – and where's the fun in that?

But what if they were all in a single neighbourhood? What if we *curated* The Power Station so that all the ingredients for a perfect day were just there for the taking: the best brunch in the capital, quirky shops, great art, funky markets, the latest films, pop-ups, theatrical performances – a constellation of interesting things programmed to change throughout the day and on into the evening.

We want to make sure that on any day of the year, people can just turn up at The Power Station without any plans – and still experience a perfect day out.

Where else could offer the guarantee of a good time?

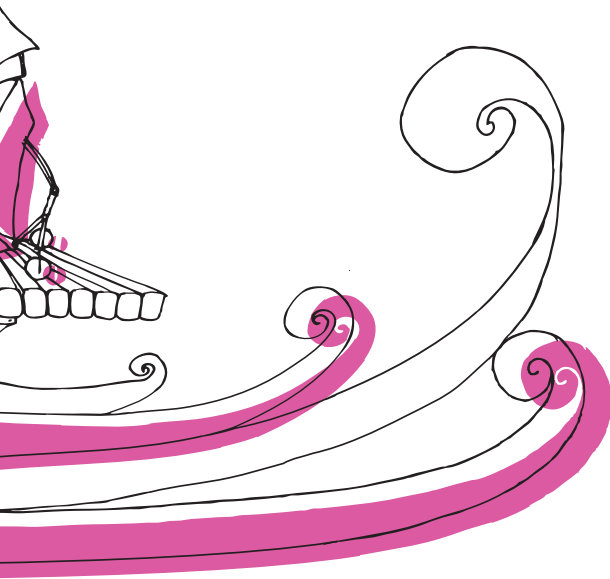

## 12. Culture culture

There are two main reasons people give for why they like going to galleries and museums. First, it's a great way to spend an afternoon with friends and family (a social experience) and second that it can often provide food for thought (an intellectual experience). Ask them again, as they leave a gallery and they might even say it was an emotional or even spiritual experience.

In other words, for most people culture is not just some pleasant diversion – it's something that can inspire them to reflect on life and help define who they are and it's this ability of culture and the arts to raise us out of the everyday that makes them so compelling.

We want people to have the opportunity to explore these kinds of experiences at Battersea and are therefore putting great emphasis on culture in all its forms at The Power Station.

It's also a way of giving the place a more independent atmosphere filled with exemplar venues – a trip to an art cinema, a groundbreaking fringe theatre, an award winning music venue or recital room, or experimental gallery space, all enable people to see the world through fresh eyes.

In addition to fulfilling the expectations of the mainstream, we want to incorporate some unpredictable elements, to bring to Battersea the thrill of the cutting edge.

We also want to support this with bookable rehearsal space for the cultural producers themselves, so there is always a sense of things happening and new works being created, as well as being enjoyed.

But more than just providing the extra facilities, we want to encourage active participation. Because more and more Londoners are looking to increase not just their appreciation, but also their mastery of the arts. Witness the number of creative evening classes, lectures, talks, and workshops currently going on every night in the capital.

So, whoever we get on board as our cultural partners, rest assured we'll be asking them to devise programmes of associated activities that ensure we are not just cultural spectators. We want everyone to be able to get stuck in.



**FACT:**

The UK has six of the top 20 most visited art museums in the world (more than any other country) and 82% of British people want to have a museum or art gallery in their local town or city.

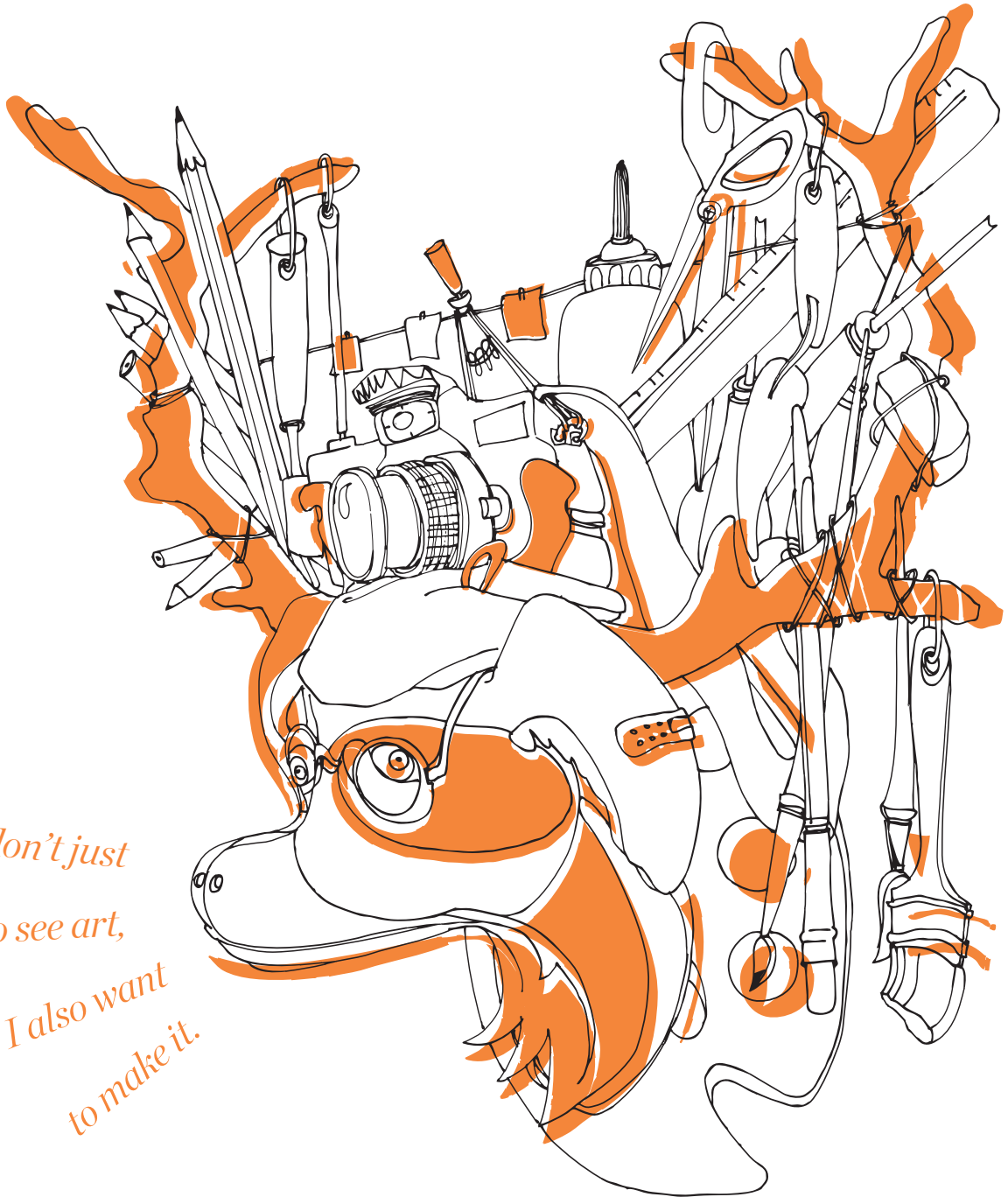

*I don't just  
want to see art,  
I also want  
to make it.*



## 13. What's on the menu

Call it the 'first law of leisure time': nobody stays anywhere long unless there's something decent to eat and drink. But then again you don't want to pay the earth every time either, just because you're a captive audience. Eating out is one of the top ten sociable things to do in London, but restaurants can be disappointingly variable in quality at any price point – the food that is, not the company.

At The Power Station we want to create a smorgasbord of eating options, ranging from high quality authentic and home-made street food, served right from the truck where the chef cooked it, to the most memorable and unique haute cuisine in London.

We're thinking about some amazing gastronomic experiences served high up in Control Room A, surrounded by the historic buttons, levers and dials and presided over by a Michelin-starred chef, who may only be there for a short season, as a guest in our curated kitchen.

The capital has seen innovators before – Terence Conran and Julian Metcalfe, to name but two – who have turned around the London scene with their restaurants and sandwich shops. But we want to play host to the next generation of culinary experimentation, so expect the unexpected, or for the less adventurous – be ready at least for old favourites with a new twist.

We'll also be putting the right kind of food and drink in the right place, at the right time – geared to the activities going on around it. So whether you're after a late night cocktail, memorable dinner, healthy lunch or the greatest early morning fry-up, it will be there ready for you to consume.

But get it while it's *hot!* Because we'll be rotating the offer, keeping it as fresh as the food and making it participatory, with cookery courses and tastings galore. Bon appétit.

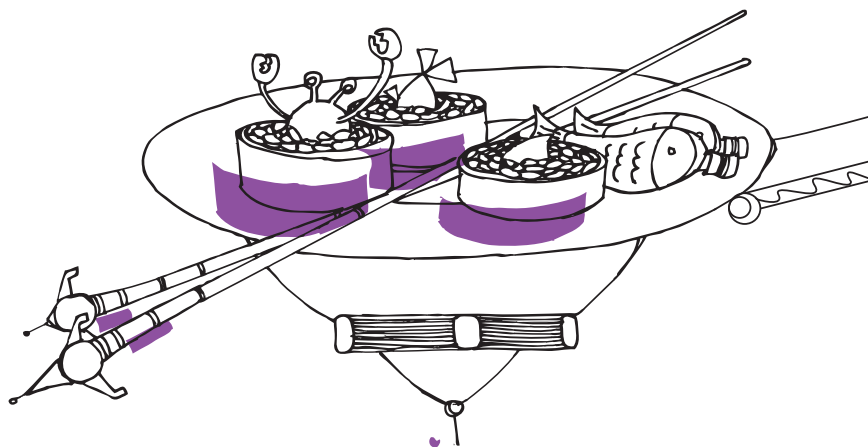

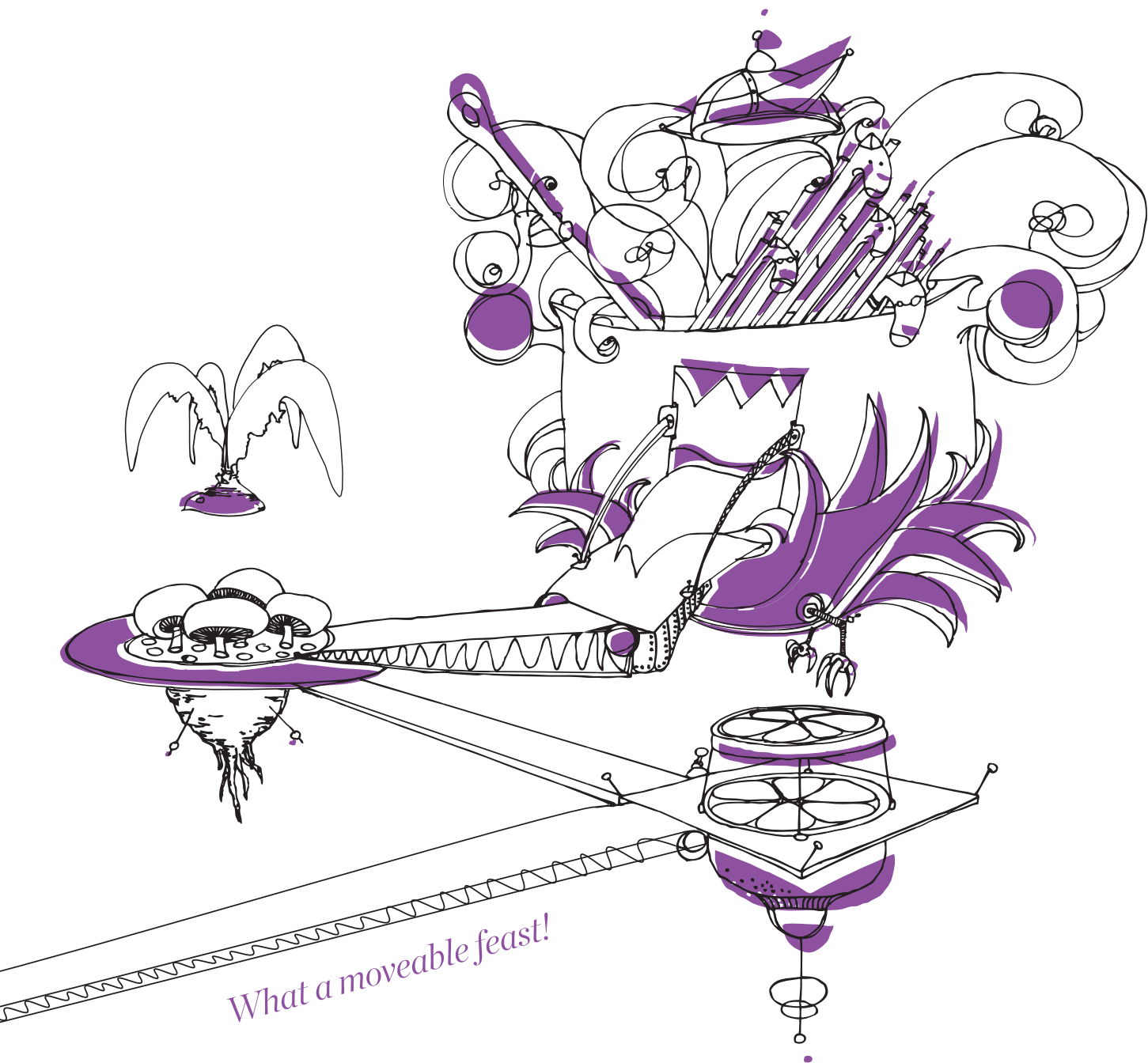

*What a moveable feast!*

**FACT:**

London's restaurants earned over 60 Michelin stars in the most recent version of the world renowned guide. Annually Londoners spend more than twice the rest of the country on takeaway meals.

## 14. Body & soul

Opinions vary on the joys of active leisure – wasn't it Mark Twain who once said *'Golf is a good walk spoiled'*?

But statistics show that both participation in team sport and personal fitness are now playing an increasing part in people's lives, even while the demands of contemporary life seem to make it harder to find the time.

In a vast city like London, it's not always easy to get to fitness facilities – and often expensive when you do. That's why we're thinking this one through carefully at The Power Station and seeing what we can do to help people deliver on those New Year resolutions to shed a few pounds.

A gym and swimming pool are clearly a must – but we'd like to make these so utterly amazing that people will still come, even after a hard day at work on a wet Monday in November. We also want to devise a more inspiring range of sport facilities, to make things more interesting. And for those who don't want to be indoors when they exercise, there'll be a running track around The Power Station to jog round first thing bright and early on a weekday morning.

So much for the sweaty stuff – what about relaxation and wellness? Being in peak physical *and* mental shape to face the world? Well we're imagining some serene and tranquil studio spaces for Yoga, Tai Chi and Pilates and in later phases we want to create the best spa in London, with saunas and steam rooms, skin treatments and detox programmes.

None of this attention to body and soul would be complete without some adjacent concessions – a juice bar, organic restaurant, true enthusiasts' sports shop and of course a health food store for all your vitamin and mineral needs. Considering the number of people with obesity in the UK has more than trebled over the last 25 years, we all need to take a bit better care of the body we've been given.

Bring on the wheatgrass.



*Ready to jump into the deep end!*

**FACT:**

According to the most recent Sport England survey, over 7 million adults (aged 16 and over) participate in sport three times a week for 30 minutes at moderate intensity.

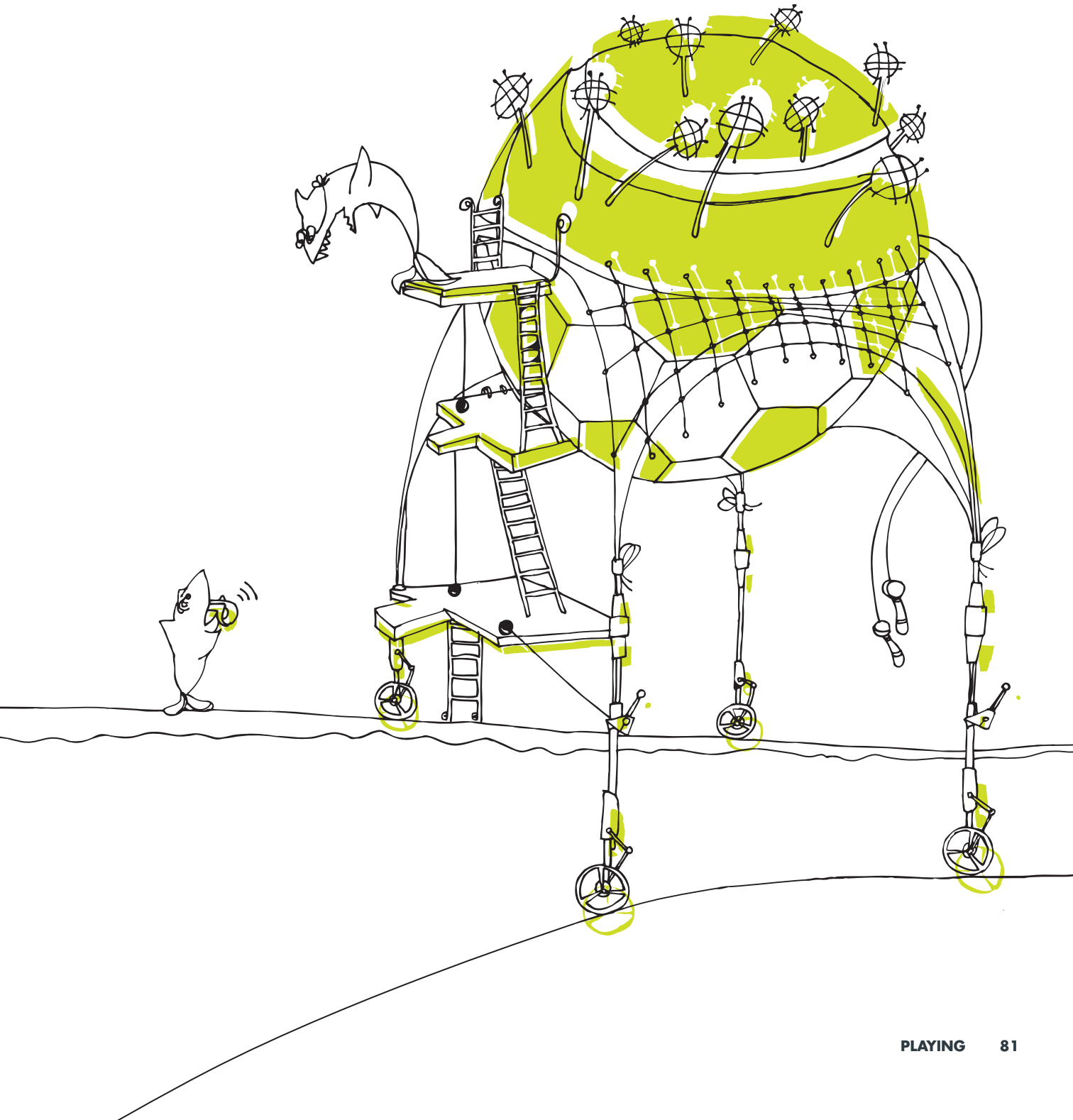

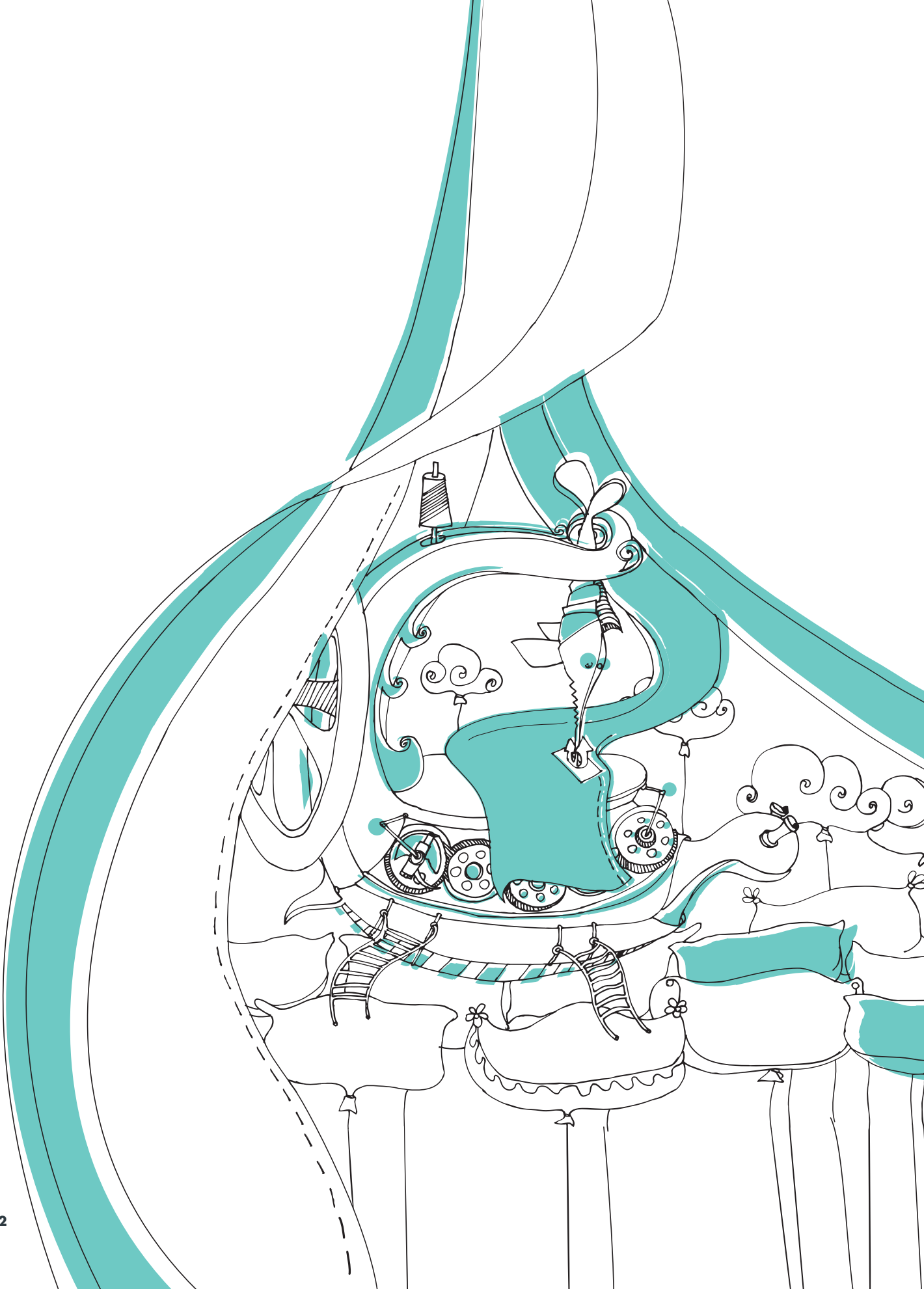

*Our own private world away from the hustle and bustle.*

## 15. Sanctuary

You live at Battersea Power Station – just a couple of minutes' walk from spectacular spaces full of people eating, drinking, shopping, playing, learning and enjoying themselves – a whole world of exciting experiences right on your doorstep.

But sometimes you won't want to step into the throng, you'll want some quiet time by yourself in your own neighbourhood – somewhere you don't have to share with the visiting hords.

In other words, like all great places, The Power Station needs some sanctuary – spaces that offer respite from the hubbub of the city and an opportunity for personal contemplation.

That's why we've designed all manner of winter gardens, roof terraces and communal courtyard spaces exclusively for residents. Some offering amazing views across London, others orientated towards the sunset, as well as quiet and secluded courtyard spaces within the residential blocks.

Like the shared gardens at the Barbican, or the private squares of Bloomsbury, these spaces offer inhabitants a private alternative for relaxation between the balconies or winter gardens of their home and from the lively public spaces of The Power Station Park.

Ahh, peace at last!

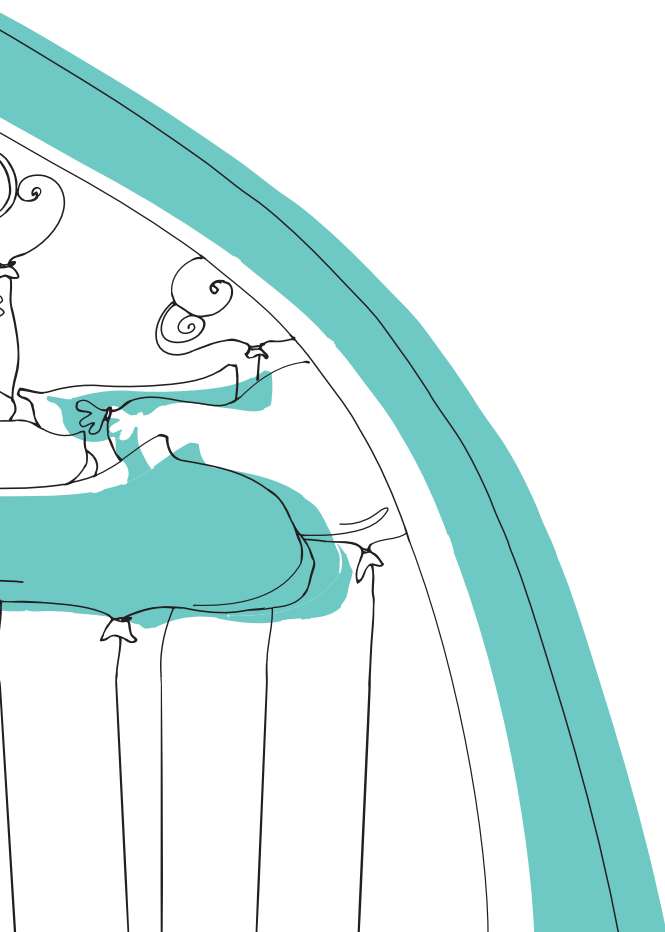

## SHOPPING

# you shop, we drop

A great day out spent shopping is the holy grail for some people, but many are tired of the ‘same old same old’.

Are you ready for something more up your street?

*Illustrations: Aurora Moreno Pavón*

Retail is a critical ingredient of any new destination neighbourhood. But it needs to be carefully integrated so that it delivers what people want and genuinely enhances the experience of being in a particular place.

To do this well it must respond to its immediate context (other local shopping options), its regional context (the rest of the city and its comparable shopping centres) and its broader context (global factors driving retail development and retail trends).

London already has a lot going for it in terms of shopping. It has been crowned a top global retail destination – with 138 of the world’s 250 leading retail brands present on London’s high streets. Its sales figures outperform Tokyo, New York and Paris.

That’s great – but these impressive accolades don’t reflect the importance and pleasure of the city’s small, local neighbourhood shops, which are the daily focus of citizens’ lives.





UK high streets are losing both beloved independent stores as well as favourite chain stores.

We need to keep great institutions going and introduce new stores people will love, and more importantly, value.

### **NEIGHBOURHOOD & DESTINATION**

To succeed, a new urban quarter needs to offer a unique blend of neighbourhood shopping and destination shopping. It's a matter of responding to divergent populations, one that lives or works there, the other a visitor population – 'grey pound', the 'youth pound' and the 'pink pound' to name a few – that perhaps is there for the first time. Each needs to co-exist, not as separate spheres of operation, but an integrated offer of practical and leisure shopping – because even the day tripper might want to buy a newspaper and the local resident will occasionally need to pop out and buy a nice gift for someone.

Urban theorist Jane Jacobs refers to this balance as combining primary and secondary diversity. This keeps the streetscape active and alive for more hours in the day.



## **CLONE TOWN**

In reality, Britain is dogged by the opposite effect – a downward spiral into banality where our high streets are concerned. A report by the New Economics Foundation (NEF) found that 41% of British towns surveyed were by definition ‘clone towns’, over-run by chain stores and with very little diversity in the mix and type of shops along the high street. Amazingly, in England, some of the worst offenders are the towns that have a reputation for being quite distinctive: Cambridge, for instance, came top of NEF’s clone town rankings with only nine varieties of shops found on its high street.

This was found to be mainly because smaller independent retailers find it difficult to compete against multi-national chains and franchises – they are the first who cannot pay an area’s ever increasing rent and the resulting pattern is all too familiar: empty shop units given over to charity shops before the next retail conglomerate negotiates a new lease.

NEF’s vision for countering this impoverishment of our high streets is to promote one that ‘does not rely on our being merely consumers but on developing a different experience of the high street which supports us to live better, more sustainably.’

To create a viable and interesting ‘high street’ and curb the tendency towards sameness and homogenisation before it happens, means operating in a very proactive and sometimes counter-intuitive way.

This can be achieved by deciding on a critical threshold mix of chains and independents, devising an innovative model of variable rent packages and briefing retail agents to adhere to this adjusted formula for retail development.

There is an emergent group of enlightened retailers who share this vision and no longer wish to be part of an identikit high street. They are often those who are already engaged in a process of ‘debranding’, in an effort to appear less commercial and more independent. In some instances they are doing this because they have seen a causal link between an over-branded environment and falling revenues. So they set about changing the impact of their signage, make shopfittings out of more natural materials and bring in a selection of merchandise unique to that store.

It is also important with a new retail development to place parameters around how retailers will be expected to design and stock their premises so that it is different to how they’ve done it elsewhere.

# Strategic thinking: Shopping

## MARKETPLACE

An analysis of some of London's main markets shows varying distribution of activity across the day and week, with some early mornings only or on specific days, others an everyday offer. Most of the successful markets are specialised rather than general.

### LONDON MARKETS

	Mon am	Mon pm	Tues am	Tues pm	Weds am	Weds pm	Thurs am	Thurs pm	Fri am	Fri pm	Sat am	Sat pm	Sun am	Sun pm
Camden Lock	Mixed		Mixed		Mixed		Mixed		Mixed		Mixed		Mixed	
Stables Market	Mixed		Mixed		Mixed		Mixed		Mixed		Mixed		Mixed	
Chapel Market			Local		Local		Local		Local		Local		Local	
Camden Passage					Antiques						Antiques			
Columbia Road													Plant	
Brick Lane													Mixed	
Spitalfields	Mixed		Mixed		Mixed		Antiques		Fashion		Mixed		Mixed	
UpMarket													Mixed	
Petticoat Lane	Mixed		Mixed		Mixed		Mixed		Mixed				Mixed	
Bermondsey Market									Antiques					
Borough Market	Food		Food		Food		Food		Food		Food			
Covent Garden	Antiques		Art & Craft		Art & Craft		Art & Craft		Art & Craft		Art & Craft		Art & Craft	
Strutton Ground	Mixed		Mixed		Mixed		Mixed		Mixed					
Piccadilly Market	Food		Antiques		Art & Craft		Art & Craft		Art & Craft		Art & Craft			
Grays Antique Market	Antiques		Antiques		Antiques		Antiques		Antiques		Antiques			
Bayswater Road													Art	
Shepherds Bush	Local		Local		Local		Local		Local		Local			
Portobello Road	Mixed		Mixed		Mixed		Mixed		Mixed		Antiques			
Church Street Market	Local		Local		Local		Local		Local		Local			

## THE CHALLENGE OF THE INTERNET

The internet has been a complete game changer for retailers, which has challenged them to find new ways to make their stores and goods worth the customer's journey.

Online retail sales are now worth over £2 billion and account for 11% of all retail sales, however, in the past three years e-commerce has grown at ten times the rate of high street retail sales. Some see this as a gradual process of 'channel switching' – that is to say, doing the research online before purchasing a product in-store or vice-versa. People are making more informed purchases: they want access to reviews, recommendations, ratings and customer service – at home, or on the go.

Today's consumer expects shopping to be about the real and virtual world coming together. They consult apps on their mobile phones at the point of purchase, or browse in a shop and then order online and afterwards return unwanted items to the store. Some are put off by the crowds and queues or find other aspects of the physical shopping environment unappealing.

To get a consumer away from the online world of retail and make them want to willingly spend their free time shopping begins with an enlightened act of management and a whole different approach to customer care. Exceeding shoppers' expectations with a range of services they do not normally experience and make it less tiring and much more stimulating.

## THE POWER OF RETAIL THEATRE

There is drama involved in the physical realities of shopping. There are real stimuli, window shopping; things to touch and feel; real interactions with customers and shop assistants; real movement through space. This drama has the potential to fulfil our psychological and physiological senses: as shoppers perform and shape their identity, their bodies release adrenaline and endorphins and they literally feel better. Some have called shopping a new religion, capable of filling a hole in our spiritual vacuum. Whatever the case, employing the tools of

the theatre – lighting, soundscape, even aromas, are effective means to enhance the retail experience, to add to the overall enjoyment and sense of time and money well spent.

Some pleasures are less visceral and have more to do with perceived enlightened patronage: supporting a fantastic local butcher, the best cobbler, or a corner shop run by a local family who really knows the neighbourhood and its shopping habits. The motivation to shop in this way is driven in a different way: it enacts life values rather than looking to attain absolute value for money.

This is often a response to a loss of authenticity. While huge retail sheds have the capacity to offer us every possible item, people are aware they're taking business away from the smaller shops that offer a more valuable experience, which contributes more to their community, even if it might come with a slightly higher price-tag.

The simple pleasure of a conversation and proper personal service often outweighs our desire to get the best price. Sometimes big and too much choice are not the best. Many of us are time constrained – a small shop with a good buyer who knows their product well – gives confidence to the consumer.

## SHOCK OF THE NEW

People have always gone to the market place to find out what's new, to see and try and taste things they've not come across before. Walter Benjamin wrote about the role of the Parisian arcades in the 19th century with their vivid shop windows of imported foreign goods and the Parisian 'flâneurs' who strolled along to see what he called the 'phantasmagoria'.

They went hoping to be surprised and entertained by exotic, rare or fascinating produce, to see new inventions and innovations and to learn something about their changing world.

A century or more later, it's still the same story – but with a new chapter provided by The Power Station.

## 16. SMLXL

The retail industry apparently knows everything about our body shapes and our shoe sizes, as well as our spending habits and our credit ratings. There have been countless media stories about the size zero issue and the super-size end of the spectrum. But when it comes to the size of new shop units, it's often a case of one-size-fits-all. Typically, a developer places their retail space on the ground floor, carves it into generous but equal-sized frontages and lets them to whoever comes along.

But this mean losing out on boutiques, the specialist outfitters or merchants who would have taken space if only a more petite one had been available. Equally, some shopping centres simply weren't designed to support mega size units and therefore lose out to a neighbouring city that had more space for the high-flyers.

We've all grown up with department stores with their various concessions and franchises and malls with little kiosks and stalls on the concourse.

However convenient for comparison shopping, none of these quite equates to the experience of walking into a small, perfectly formed shop with a smell and an atmosphere all of its own. Nor does buying an item from the limited range in a department store come anywhere close to walking into the fashion house's own one-off emporium complete with dramatic chandeliers and original artwork and seeing the whole range on display there.

In short, we think that size matters. For two reasons. Because the shopper enjoys wandering in and out of shops that aren't all the same scale and more importantly because it's a clever way to get new retailers in to test out new ideas.

At Battersea we've got lots of scope to exploit the effects of scale and hierarchy – from kiosks all the way up to flagship stores.

**FACT:**

Various bodies have defined a small store as 3,000 sq ft or less. Selfridges' Oxford Street location, currently named the World's Best Department Store and the second largest store in the UK after Harrods, is 540,000 sq ft. You could fit 180 small stores into Selfridges.



*It's true, variety really is the spice of life.*

**FACT:**

In 1987 Gap opened its first store outside of the United States in London.

*Looking back, it all started here.*





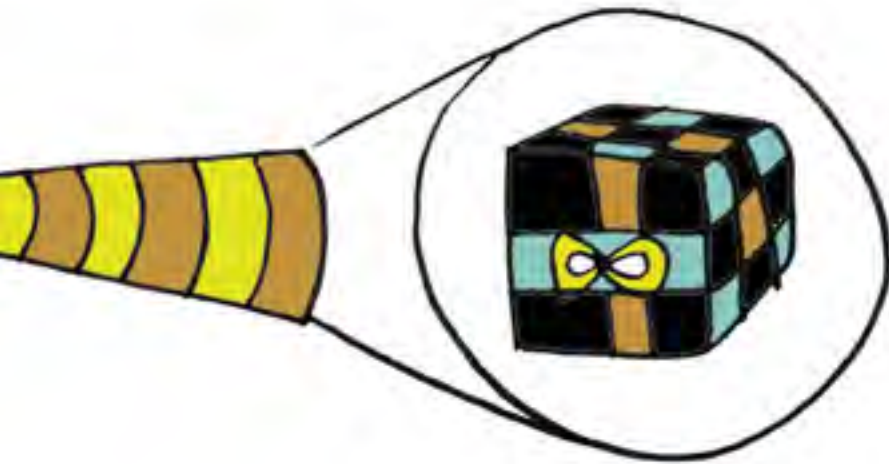

## 17. You saw it here first

London is the place where retailers from abroad tend to test the UK and EU market – and these new arrivals quickly become a shopping hot spot for people in the know: it's what happened when Abercrombie & Fitch, Urban Outfitters and American Apparel all opened. And that's just some of the newcomers from the US.

It's been the same story with the arrival of Muji and Uniqlo from Japan and other stores from mainland Europe like Viktor & Rolf and Agatha Ruiz de la Prada.

London is also no stranger to flagship stores and ground-breaking new retail concepts either. London can lay claim to quite a few retail firsts: Harrods, Liberty, Selfridges, Heal's, Hamleys, to name just a few. Some have never opened a second store outside London, let alone the UK. They simply didn't need to.

At Battersea Power Station, we want to extend this tradition of playing host to new retail concepts, of welcoming new arrivals from overseas, a little further. We want to introduce more theatre, more drama, more wow. Who knows, in the years to come we may produce another one of those world-renowned emporia London is known for.

So, at one end of the spectrum we want to talent spot, invest in and help pave the way for someone's innovative boutique concept to hit the market in an original way, whether they're an emerging fashion designer, pastry chef or furniture maker. And at the other end of the spectrum, we want to provide the kinds of retail space that make the retail scouts' mouths water when they are out searching for where in the world to locate their next store. We want them to beat a path to our door, because nowhere else can offer the same level of retail theatre: You saw it here first.

## 18. It's a one-off

Battersea Power Station is a bit of a one-off, so it would seem strange if we just filled all the retail units with everything you've seen before. We will have some familiar stores, of course, but interspersed with something you won't have seen before, or at least not in that format.

Above all we want retailers who see themselves as putting down roots and building up a loyal customer base. By wooing a healthy number of independents and getting them set up here we'll be attracting retailers who know a thing or two about what it takes to make people come back time and time again.

An out of the ordinary shopping destination is less about the glitz and the gloss and more about the low key and inviting. It's casual yet attentive, slowed down and yet time-effective. It has texture and tactility, it never sounds harsh or abrasive and it smells good. All these things are hard to achieve if you've only got plate-glass, suspended ceilings and fluorescent lighting.

So you might find a cluster of alternative outlets at Battersea and we'll be doing everything in our power to create the right circumstances to help these interesting and independents to flourish and remain here. We don't want to find that in 20 years time this pioneer quirkiness is just a dim and distant memory. We plan to be unique for good.



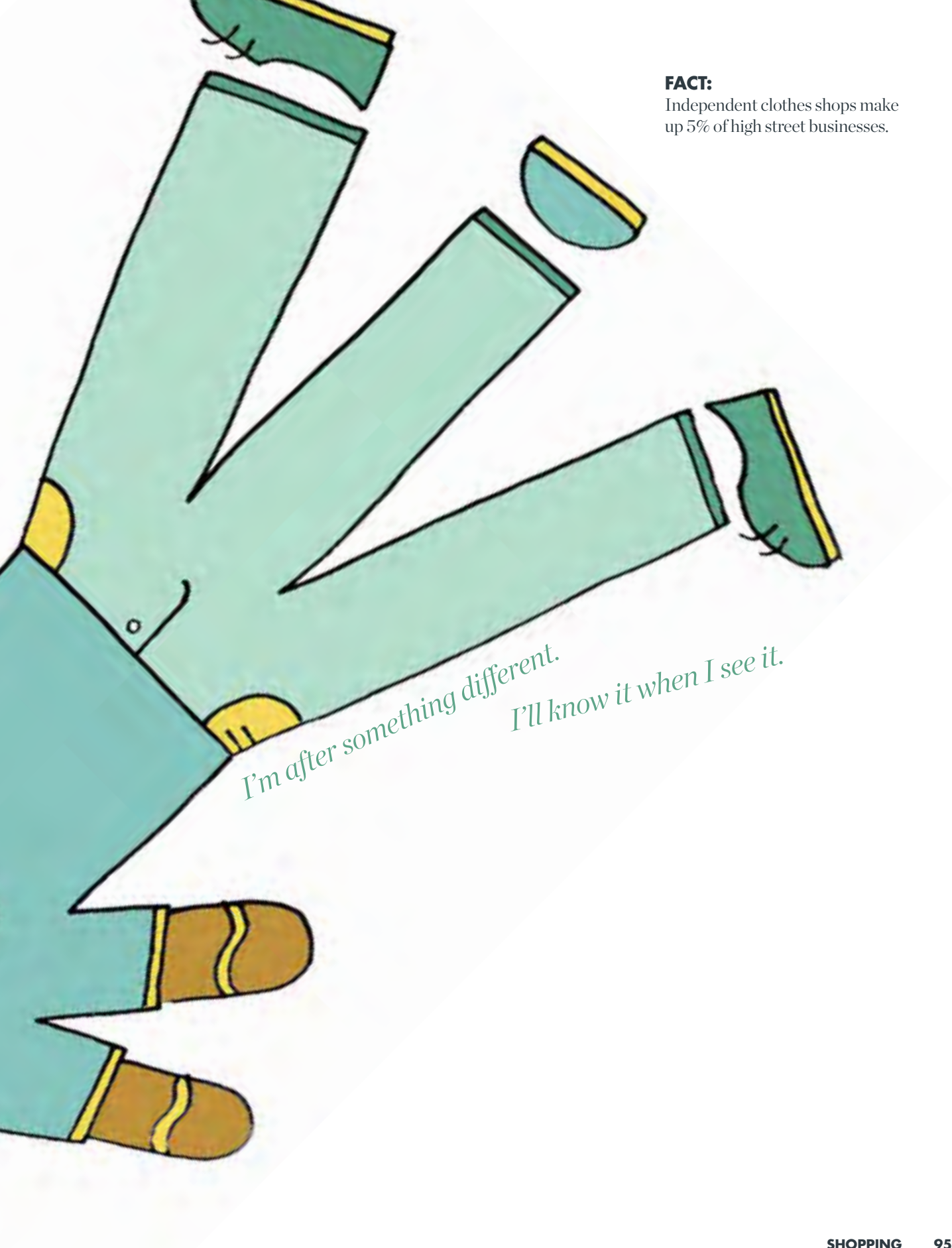

**FACT:**

Independent clothes shops make up 5% of high street businesses.

*I'm after something different.*

*I'll know it when I see it.*

**FACT:**

The UK population spends over £150 million per year on groceries with each person spending on average around £2,500.

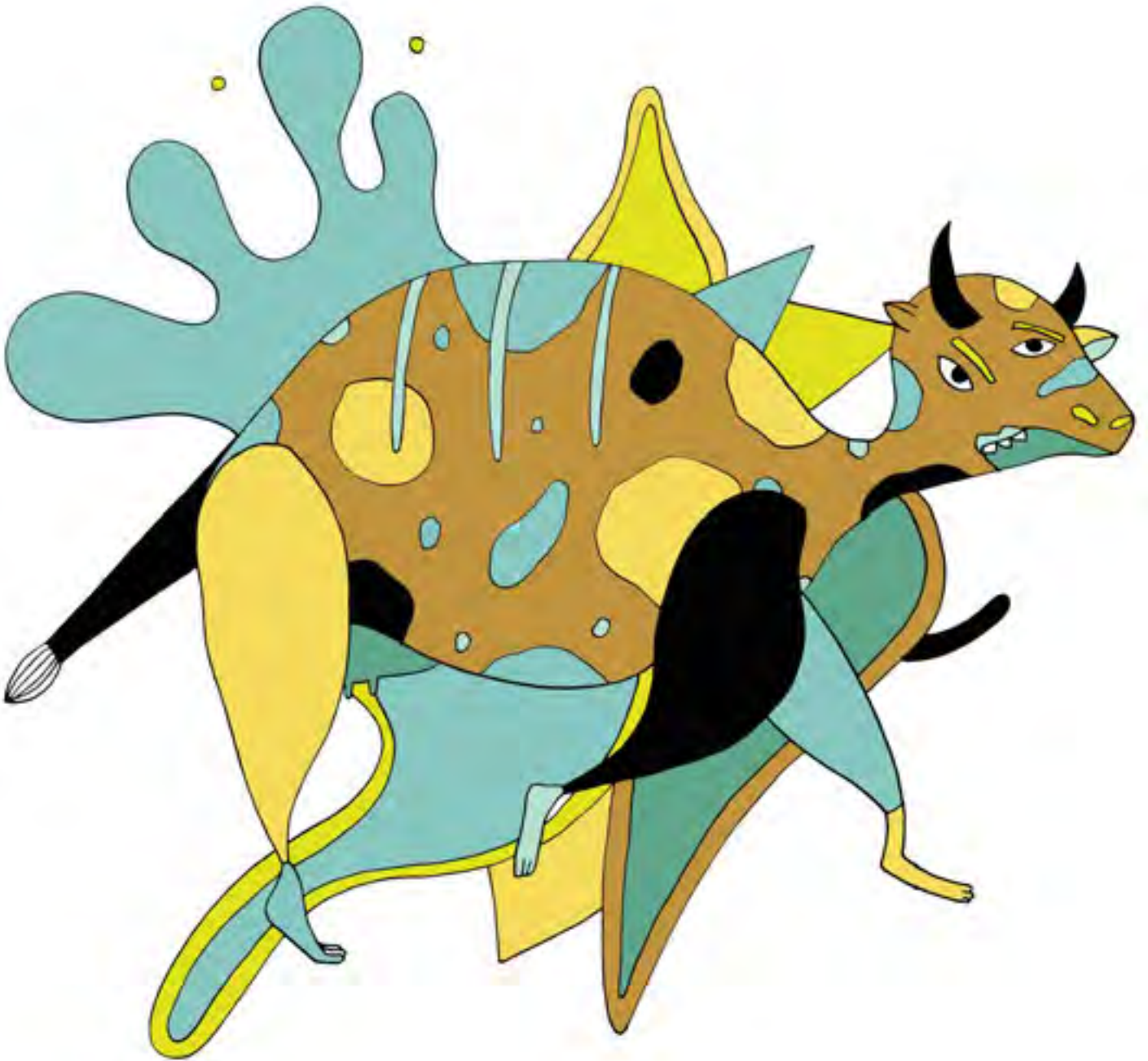

*Essentials should always be just down the road.*

## 19. Bread & milk

Let's be practical for a moment. We're staggered by the fact that lots of recent urban developments are a virtual desert as far as everyday items are concerned, especially at the weekend. The one or two retail units that were shown on the drawings never became a mini-market and a dry cleaners as planned and as a consequence there's not so much as a pint of milk or a bar of chocolate in sight.

It's the same story whether we're talking about residential or retail-led developments – you can't just pop out and pick things up. It would appear that normal, everyday practicality doesn't pay.

We want to change that approach at Battersea Power Station by bringing together a great mix of practical as well as pleasurable. We'll earmark units for the basics you'd find in a local parade rather than expect a major supermarket to step in. This will include a bakery, a florist, a hairdresser and a newsagent for starters.

More than that, we want these local shops to be run by local business people who know the area and want to expand into new premises and become part of a new neighbourhood. Building up our shopkeepers' sense of belonging is as important as developing a loyal customer base.

This is bespoke convenience: tailor-made for its neighbourhood, stocking the kind of everyday things as well as some speciality items, so that people who live here can get the things they need, even at the weekend.

## 20. Constant change

In a city like London, newness and novelty are old hat. So to speak. Like the notion of pop-up: there's something popping up every week and even if you spent every waking minute checking them out, you'd never get round to all the temporary store openings, limited run restaurants, sample sales, in-store fashion shows and speciality markets. The trick is to be the best, not just in the run-up to Christmas, but every day.

It's all about the rhythms of retailing – mixing in to the overall picture a few side stalls here and there, that bring a new crowd or extend the shopping experience to another part of the day or week, celebrating and curating our way through the calendar with food, drink and a constantly changing festive atmosphere.

When Borough Market was lovingly revitalised, people realised from day one it was something special. They made a special trip there to sample those marvellous British cheeses on offer. Then it became a regular Saturday haunt, complete with brunch and a walk along the river. In the past ten years, it has seen its annual number of visitors rise from 50,000 per year to 4.5 million. It's all about curatorship, identifying and displaying the right combination of goods at the right time for the right audience.

We're well aware that pop-up has to mean more than some kind of market-cum-bazaar every now and then at Battersea; we want our visitors to come all year round, spring, summer, autumn and winter, and find way more than they were expecting.



**FACT:**

London is home to over 160 street markets supporting 7,300 jobs with a combined annual turnover in excess of £430 million.

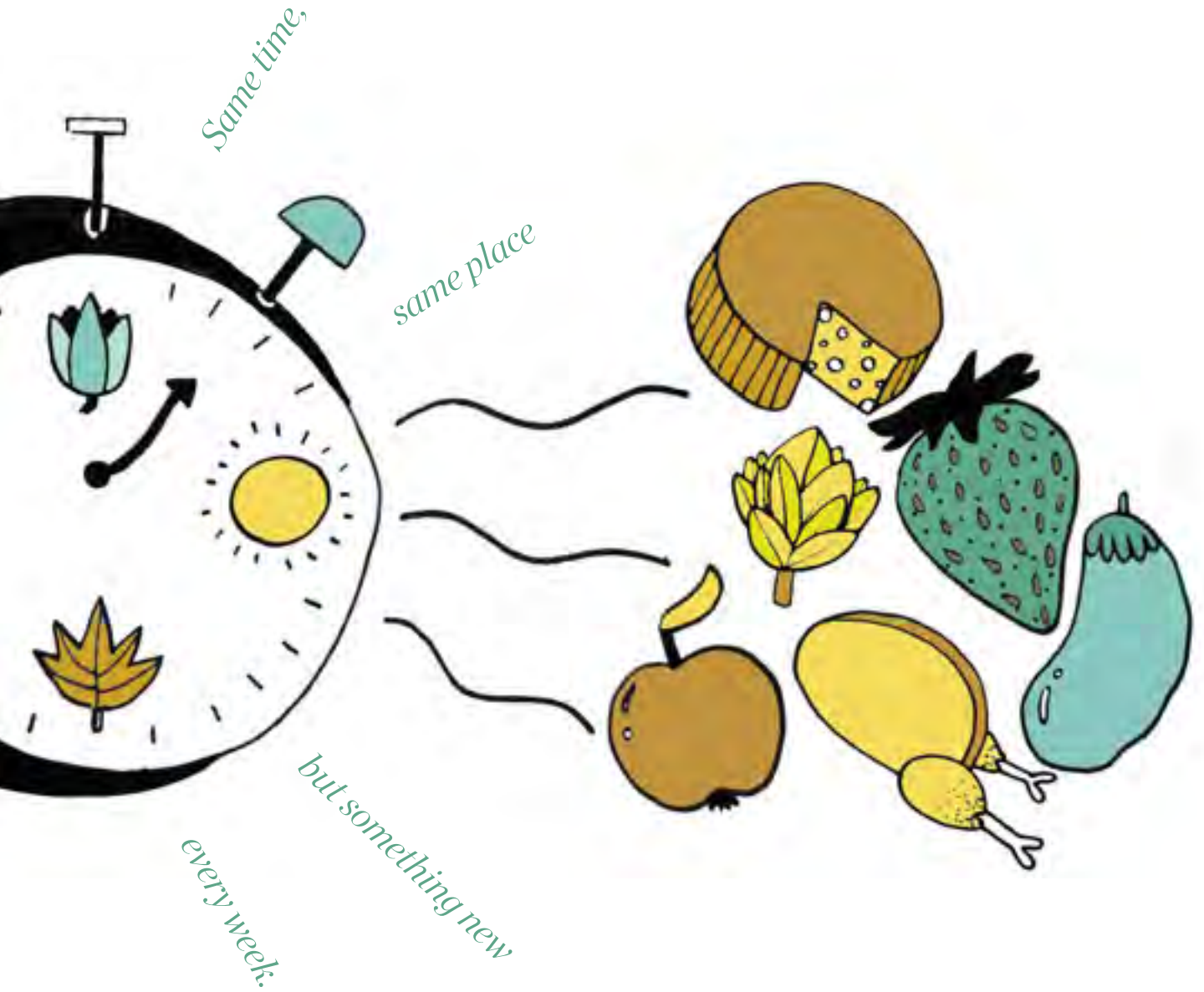

## 21. Retail+

You know what you're getting when you go to an out-of-town shopping mall: it's easy, you turn up, you park your car, you get what you want. Or do you? It's about ease of use, but you often have to walk miles to get to the first shop. It's about convenience but you might not even be able to buy toothpaste. It's about critical mass, but often the shops repeat themselves and you get disorientated.

Our visitors need to feel completely pampered – valet parking, their own personal locker and/or shopper, a sumptuous members' lounge with great free coffee and complimentary massages, and of course, the best toilets this side of... hmmm, we need to check out the competition on that one.

Retail+ is about getting everything right about the place before you even think about installing the shops themselves. It's about making the place somewhere amazing and enjoyable to be, even if there's nothing in particular you've come to buy. It's about asking why can't you buy underwear at ten o'clock in the evening if you want to? Why not meet your personal shopper for an hour before work if you want to? What if there was a place you can go afterwards to try everything on or get ready to go out?

More than that, it's about a whole step-change in customer loyalty and reward programmes – inviting them to pre-launches and special evening sales events and seeking their involvement in innovative secret shopper schemes that will improve and enhance services month after month.

After all, if we don't make it a completely satisfying total experience for people, they might as well stay at home and order the same stuff online.





*The best customer service is the kind you least expect.*

**FACT:**

About 86% of households in the UK have at least one loyalty card to a supermarket, according to the market researchers, TNS.

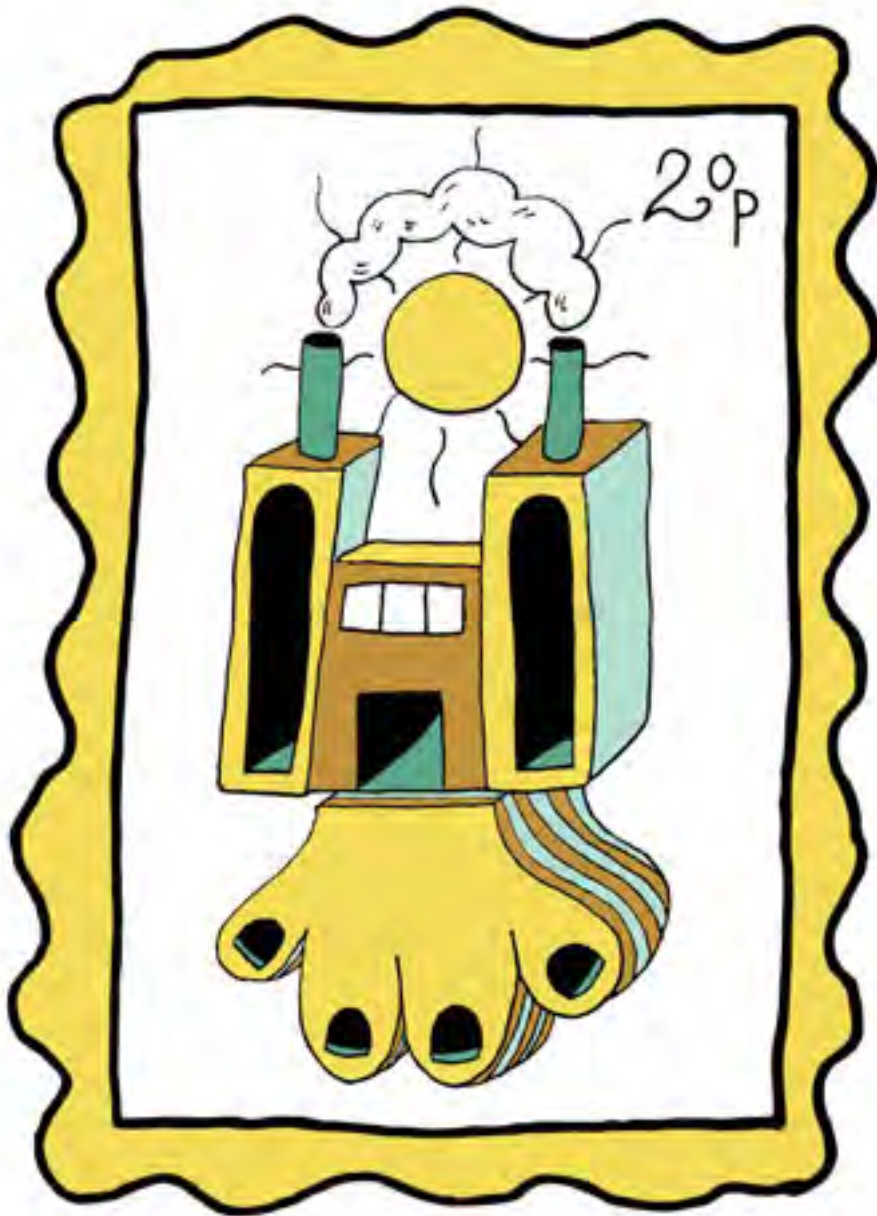

*It's got our name written all over it.*

## 22. BPS: the brand

It's iconic, unique, raw and authentic – in short it's every brand manager's dream and with so much interest in The Power Station, it's inevitable that people will want to leave with a piece of the action.

But creating a retail brand around The Power Station is not about lazy 'merchandising' – slapping a logo on tea towels, mugs and baseball caps. No, it's about capturing the spirit of the place and staying true to our principles – putting culture and the arts first, championing design quality and encouraging personal creativity.

It means commissioning creative and innovative products we want to carry the BPS association. We're thinking in terms of limited edition prints and original artworks, seasonal collections of clothing by guest designers, remarkable furniture and unusual

products that have the same energy and vibe as Battersea. It also means tracking down things that already exist – books of industrial photography, maybe some interesting architectural salvage – that recall the heritage of the site.

When you see what we bring together you'll know instinctively why they are all there. And another thing: it won't be available for sale anywhere else. Unique. Like The Power Station.

The Battersea shop will be pride of place, a wonderful, sociable 'third space' – somewhere you'll want to browse, have a drink, chat to friends. Part installation, part gallery, part museum, but full of inspiration you can take home.

A is for Apple. B is for Battersea.

### **FACT:**

In 1977, graphic designer Milton Glaser donated his services to the 'I Love New York' campaign, now known the world over, to help promote New York State tourism. Today, it continues to anchor the State's tourism marketing efforts.

**WORKING**



# is what business as usual?

If the way we work is changing,  
why isn't the workplace  
keeping up?

*Illustrations: Nick Alston*



The transition from a manufacturing to a knowledge-based economy precipitates big shifts in the how, where and when many people work. Who would have thought 100 years ago that today 13% of the UK workforce would be primarily home-based – perhaps a figure we have not seen since pre-industrial times. Overall, the working population now also works a longer week than compared to 20 years ago (3 hours longer than in the 1980s).

While work style (how), work space (where) and work time (when) are all changing simultaneously, to understand the changes happening in space and time, one first needs to look at the emerging and evolving work styles.

As work styles become increasingly more diverse, so the spaces where work happens are becoming harder to define.

### **CHANGING STYLES**

The shifting nature of today's work styles reflects greater levels of innovation and collaboration in the business world. StartUp Britain reports that over 500,000 businesses were registered with Companies House last year, with advances in technology helping to truly push the boundaries of how any business develops. Take the UK's internet economy. It clearly reflects a major shift towards a knowledge-based society – according to the Boston Consulting Group, the UK internet economy was worth £131 billion or roughly 8.3% of GDP. This figure is projected to reach 12.4% by 2016. Some of these internet start-ups in future will be based at Battersea Power Station, if the offer is right.



Getting it right will mean responding also to a shift in both people's and companies' desire to do good. There's an ever-growing rise in the number of social entrepreneurs and for-profit social ventures – companies who seek to effect social and environmental change directly through their business. Some ventures make the headlines, like Jamie Oliver's Fifteen restaurant, while others are small-scale and locally based. Even some of the world's largest companies, such as Virgin with its Carbon War Room, are branching out to focus on how they can give back in some way. The UK is home to a high proportion of these new social entrepreneurs, with 1.7 million people now involved in social ventures. Battersea Power Station has the potential to tap into this movement and grow the future of social entrepreneurship, right from Phase 1.

## **CHANGING SPACES**

The way we use office space is evolving rapidly. For many people, work is no longer tied to a desk in a particular location and can happen almost anywhere. Many organisations, including the UK government, are asking how they can use their existing space in a smarter and more efficient manner. Leading workplace design experts DEGW say this is not about addressing design and productivity per se, but is about making sure people can work “in the most appropriate setting for the work they're doing, regardless of location”. The onus is therefore on the workplace to offer an increasingly more flexible environment to accommodate a wider range of uses and users.

This has led many to seek out space with a different ambience to typically bland Grade A new build office space: for some time, the more hip and vibrant

companies are now occupying former warehouses, factories and lofts, many of which have a similar history to Battersea Power Station and are capable of being transformed into some of the most dynamic work spaces. Anything with a rich architectural legacy affords something extra and it's what visionary go-ahead companies are now looking for.

Battersea's appeal is not unlike New York's Chelsea Market, a former Nabisco Biscuit Factory, which now has an impressive tenant list : Google, Food Network, MLB.com – the official website of Major League Baseball and local cable news channel NY1. But it was not only the raw quality of the industrial building alone that made them want to move in – Chelsea Market also made great strides in getting some extremely dynamic ground floor retailers and food outlets installed.

It all points to the fact that people are now taking a more neighbourhood approach to the workplace – there needs to be a good café nearby with power outlets, Wi-Fi and good networking possibilities. Having these other spaces, often called co-working spaces, on hand allows people choice and variety in their daily routine, but they also play host to a much wider range of events throughout the working week and after hours. A diverse and richly augmented offer in terms of work space location is increasingly important, not purely in terms of reducing occupancy costs, but has been shown to stimulate creativity and enhance productivity – something which in a knowledge-based economy is more difficult to achieve. It's no longer just an issue of optimum ergonomics.

## **CHANGING TIME**

Where and how we work is changing in large part due to when we work. Of course, there have always been shift workers, but today's technology has enabled many people to have greater flexibility about how and when they align their working and private lives. For some this means working two days a week from home, while for other it means starting and finishing the day earlier than the majority of the office. Fewer than two-thirds of IBM's employees are office-based. The think-tank Demos report, 'Reinventing the Workplace' found that 91% of employers in the UK offer at least one form of flexible working arrangement to their employees and almost 60% of employees stated they currently used a form of flexible working.

Our free time has also become increasingly important to us; indeed Demos' research also revealed that the second most popular reason given by employees in the UK for wanting to work flexible hours was to achieve more free time – which is not usually about shortening the working week but about reducing time spent travelling to and from work. Locating an office in a neighbourhood that not only has great opportunities for free time, places to go for lunch, a decent gym, a few bars to go and unwind at the end of a long day but that also has good transport links is now at a premium – these are things that Battersea Power Station will easily be able to lay claim to.

## **WORKING AT THE POWER STATION**

We're anticipating that Battersea Power Station will have a working population of 15,000 people across 1.7 million sq ft of office accommodation, working for companies of all sizes. We want future workspace tenants to say things like "How could our company have found anything better than this anywhere else in London?" We want to hear that right across the board, from the home-based entrepreneur to the company that regularly appears in the FTSE 100. By boasting a dynamic range of spaces, both small and large, from studio to flagship, Battersea Power Station will excite the kind of organisations that together will help to create a flourishing business community with all the social infrastructure a city centre location has to offer. Because a city, a neighbourhood or even a workspace is only as good as its people.



# Strategic thinking: Working

## A SITE-WIDE APPROACH

Attracting smart tenants and organisations  
– advanced working benefits.

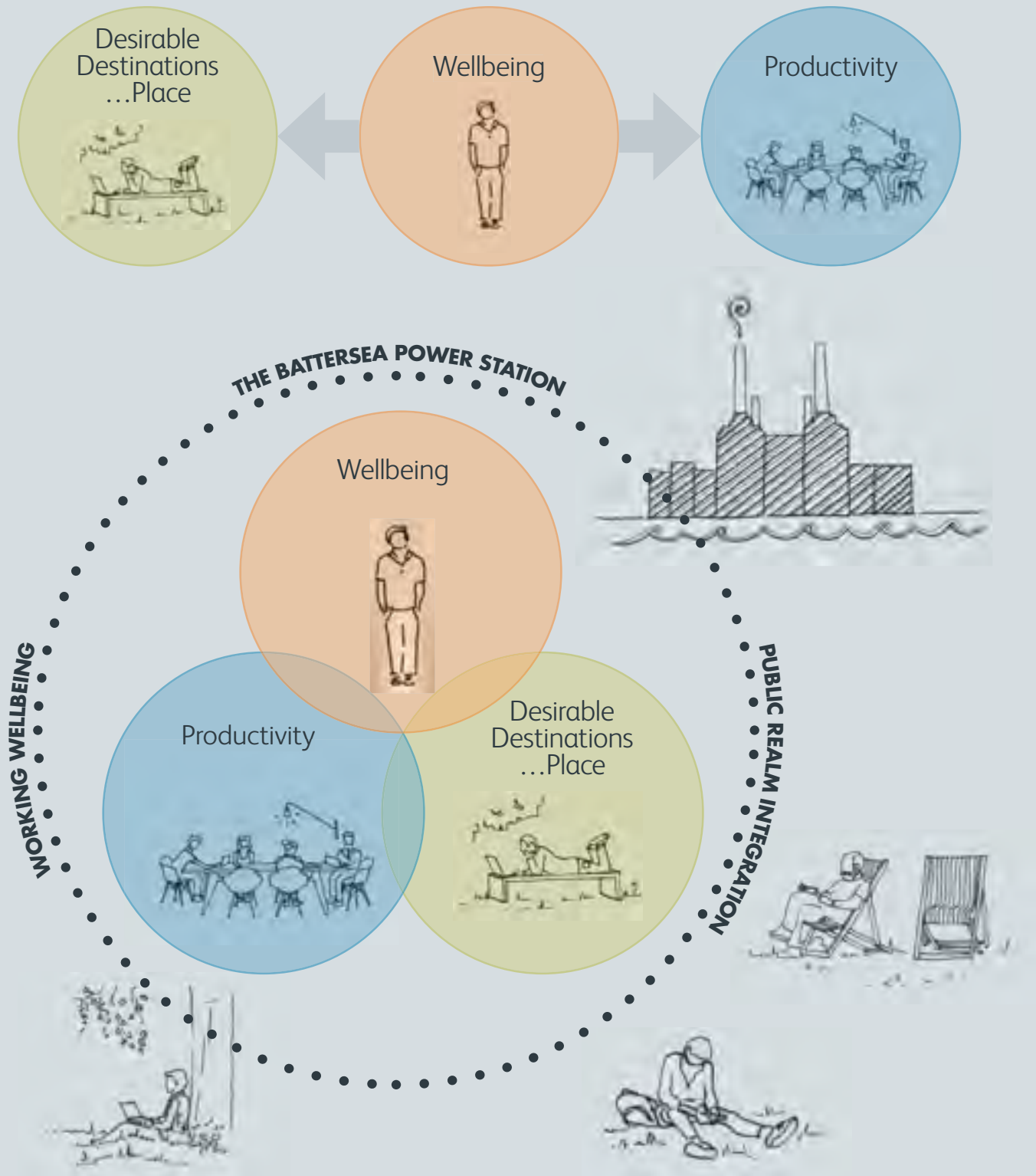

**FACT:**

Count Google, Apple and Mattel among the organisations that first set-up shop in a garage.

BUSINESS HUB

PLAY SPACE

*What's out there?  
Is it right for me?*

ROOF TOP CLUBHOUSE

NETWORKING

WAREHOUSE

CONFERENCE CENTRE

LARGE FLOOR PLATES

## 23. Anticipating demand

You know those old warehouses on the edge of every town, crammed between and under railway lines and such? They've been a breeding ground for all kinds of companies over the years and there's no shortage of demand for them. It's the sort of commercial space your average developer wouldn't think about including in the centre of London – because it's not high value enough.

Or is it? Often, it's in these kinds of spaces where innovation is really happening, so we're keeping options like this open as we plan the working community we'd like to attract to Battersea Power Station. It's the diversity we're after, the cheek-by-jowl nature of a greasy spoon café next door to a posh designer furniture shop, next to a local up-and-coming web design company, but on a much bigger scale.

Today's office offer has to be ready to accommodate people who work with their hands and also support and inspire those who rely on a computer. Wouldn't that be better than exclusively catering for large corporations behind plate glass facades?

Conversely, why should it only be the start-ups who occupy interesting industrial spaces? At Battersea Power Station, we have large warehouse spaces with a Grade A specification allowing even companies with 500+ employees to take up inspirational space within this icon. We want to provide more of what's not available in many other office schemes across London. The specification we're developing is based on taking a long hard look at what's absent on the supply side and responding more to what the demands are likely to be in the foreseeable future.

Apart from accommodating multi-national companies, we will cater to people's businesses, which are likely to grow slowly, rely on each other more and take fewer risks. That's how the world now operates and we need to ensure supply meets demand.



## 24. Creative quarter

Yes, it was a buzzword from the 1990s right through the 2000s. Yes, it spawned loads of places claiming to be the newest hotspot for creative companies. And yes, we know for these and lots of other reasons, it's become a bit of a cliché. It seems as though to say an area is a creative quarter and to actually be one are two different things. In fact, those who say it invariably aren't.

Getting creative people to come and work in a particular neighbourhood makes it feel attractive and successful to a much wider spectrum of people and it's how you get that virtuous spiral thing going. There's already a notable concentration of creative companies in the Wandsworth area and it's something we have strongly believed we need to build on from the early days. So who are they? Vivienne Westwood for one. Norman Foster and his architecture studio. Victoria Beckham and her growing fashion studio. Simon Fuller's 19 Entertainment to name one more.

To grow this creative quarter, we want the next wave of fashion houses and design studios, who are crammed in some little studio in Soho or Spitalfields and desperately need more space to do their stuff to think 'eureka: Battersea!'

Creative quarters provide the opportunities to build the right associations: hosting killer events that are the highlight of the fashion, art, music and design calendars; televising new product launches and film premieres, as well as glittering awards ceremonies; and creating a real cultural draw with our galleries, cinemas and theatre spaces. It can't just be all work and no play!

We want these associations to be proper lasting local partnerships set up to foster more business all around – the ultimate win-win scenario. It's about showcasing stuff that's going on right on our doorstep and making more of the happenings all around us – in Battersea Park with the Affordable Art Fair and its Pump House Gallery, at the Royal College of Art's Schools of Fine Art and Applied Art and in the studios of the world leading Royal Academy of Dance.

This will only be possible if we establish good links with other companies based in our vicinity and in so doing make a virtue of our location as being more edgy and vital than the more corporate city and West End locations.



**FACT:**

The creative industries is London's second largest sector, worth \$32 billion per year. Wandsworth is ranked 4th across London boroughs for total number of creative industry firms.

But for Battersea's creative quarter to establish even stronger roots at The Power Station, we have to think about how we get to a situation where people can start small and build up their creative enterprise without having to move on, because there is enough variety in the types of premises and scope to use it in radically different ways, from the smallest units up to floors of serviced space? How do we provide rent and lease initiatives for some so that they can establish themselves and in turn, this area? What's the basis for doing that and will it work? What could help sustain the creative vibe of an area in the longer term? This is what we're investigating.

We need to learn from other locations like New York's Meatpacking District, a corner of Manhattan that has now become a hotbed for creativity and the place to be for the city's tech companies. We need to understand why it is that 'new ideas need old buildings' and how creative people manage to punch above their weight so that Battersea Power Station can do likewise.

Watch this space.

*How can we keep the people who made this area?*

**FACT:**

Inefficient buildings cost British businesses £135 billion per annum and a better designed workplace has been shown to improve productivity by 19%.

*I want space that reflects me and my company.*



## 25. Blank canvas

Some companies want plug and play – new office space that’s already kitted out, looks great and all they have to do is pick the colour of the carpet and order some new swivel chairs from a catalogue.

There are others who’d rather move into a knackered old warehouse, fix the leaky roof, get some industrial heaters and big sofas, then sit and savour the rawness of the space and the myriad of possibilities it offers them.

We’re lucky at Battersea Power Station, because we can offer both of these workspaces and everything in between – so there will be something just right for everyone, whatever they do.

We’ve also got a pretty big leaky roof to fix.

But after we’ve done that, the authenticity of the space we can offer will be second to none. We think we should let tenants come in and work their own magic. They know better than we do what it takes to keep their teams inspired and motivated and if that involves installing an indoor climbing wall or a giant fish tank, it’s their call. We’ll provide the robust structure, the bare brick walls and the polished concrete floors that can act as a starting point.

Blank canvas is about facing up to immense potential. It’s also an invitation to do things differently – a new start. The first brushstroke for us is to fill in a tiny bit of the top left hand corner of a vast 40 acre canvas. It’s going to be a lot of fun, but we need some pioneering companies who like all that rawness and who’ll get a kick out of being part of the Battersea adventure right from the start.



## 26. Homeworking

So what's the appeal? If one in eight of us is now regularly working from home and it's the fastest growing trend in the world of work, there must be a reason. It's partly that we're not talking kitchen tables and second bedrooms any more – although there are probably some that make very nice offices – it's a whole lifestyle choice nowadays.

Homeworking is not so much about the place you choose to work, it's also about the *time* you choose to work and how that allows you to make work fit in better with the daily rhythm of the other parts of your life – a fitness class, walking the dog, collecting the kids from school.

At Battersea Power Station, we're imagining a whole new world for our homeworkers, starting from their home environment and working outwards to explore all the ways we can help make working from home fulfilling and effective. Their 'to do' list goes something like: make a few calls (over breakfast on my balcony); two hours working on the laptop (in the sunlit café at the bottom of my block); video conference with new client (in my business centre across the street).

In other words, it's a world in which whatever people do – make wedding cakes, import tea, manage musicians or write filmscripts – their home and their homes-from-home nearby can support it. Some people won't want to work at a desk at all, but if they do, we're making sure there are at least two or three spots in our apartments where they can get the focus, the lighting and the Wi-Fi just right and then shut it all away when downtime calls. And for a complete change in scenery, they can go downstairs to the business hub and see what their neighbour is up to or rent a meeting room when the second bedroom just won't do for that all important meeting.

There are some 4.5 million workers in the UK who still want to work from home but can't. We want Battersea Power Station to be the number one homeworking address in London and in the process convince a load more corporate employers of the upsides of homeworking, so that anyone can work at their kitchen table, if they want to.



**FACT:**

People in the UK working mainly from home has risen over 20% in the past ten years, with the highest proportion of people found in the south west and south east of England.

*If only I could get a change every now and then...*



## 27. Co-workers

While there is an increase in the number of people working out of their homes, the number of people running their business from their favourite café, or even conducting business on a train, is also on the rise. We now live in a world where work can happen just about anywhere. We simply touch down and get on with things.

However, for some, getting down to work is about having somewhere to go. Some might call it the office but really this is about co-working spaces. Places that offer shared work space for everyone, from the business traveller who needs an afternoon to finish a presentation, to the local independent contractor who likes being in an environment where they can meet like-minded people and even find potential collaborators.

London is a world centre for knowledge work and social entrepreneurship, much of which is based around co-working, so if Battersea is to be a key player in this, we must provide the means and spaces to support the creation and dissemination of knowledge work that are second to none.



**FACT:**

There are over 1,200 co-working spaces found around the world.



*Connect us  
to everyone  
we should know.*

At Battersea, we're looking to create our own form of co-working where our residents can work side-by-side with some of our corporate office tenants who are after a change of scenery for a brainstorming session or overflow space for hot-deskers in one of the available meeting spaces. Or a production team that needs somewhere for three months to finish up a documentary. Co-working at Battersea will cover all these needs.

Battersea Power Station was built to function as an energy hub – bringing in coal and, in its boiler houses and turbine halls, generate electricity for the Grid. Now it's going to bring in talent and turn this into products and services to put out on a much wider and more global grid. Let's call it People Power.



*Somewhere to grow –  
one step at a time.*

**FACT:**

Lease lengths have basically halved since 1992. The average lease length is now 5 years.



## 28. Flexible terms

We were told by workplace expert Davida Hamilton that one of the biggest challenges for companies is being able to expand from *'one to many'*. There are many factors that have to align to ensure this transition goes smoothly and one of the biggest is the issue of space. We want our workspace tenants at Battersea to be able to adapt their future space needs to suit their ever-changing circumstances with confidence, whatever happens.

For this reason, in certain circumstances lease terms will be variable to meet tenant's needs – with some tenants even starting on a simple flexible lease to help them get going and to allow for fluid expansion or contraction, because we really want to have them adding to the rich mix at Battersea. And we'll offer long lease periods to large multinationals who want to stay put.

Sometimes all a company needs is some extra project space for a couple of months to edit a feature film or a few more desks to be able to put out a new collection. They want some bookable meeting space for their monthly board meetings and once a year they want to get their whole team together in London for a conference. We are looking at ways we can provide for all these and more, with a flexible serviced offer that we think will become the hallmark of Battersea Power Station's success.

We should be able to give that to them; it's not rocket science – it's just a bit lateral.

## 29. Working+

To provide the ideal workplace takes a lot of thought. It's about having the right environment within the confines of the office walls and having a special offer on the office's doorstep. At Battersea Power Station, you can have both.

Seeing that the British already do one of the longest working weeks in Europe, we're looking at how we can make our tenants' lives just a bit easier. By putting in place a dedicated facilities management team, who will take care of the cleaning, the recycling, the entry codes, etc., we will let our tenants, from the two person team in the co-working space to the global multinational inside The Power Station, concentrate on the more important stuff – like landing their dream client. We will also make sure you have opportunities to meet your fellow tenants because, you never know: your next collaborator could be right across the hall.

While ensuring our tenants' offices run smoothly, we are also mindful of the little things in life that help to make the working week all the better. You should be able to enjoy a plethora of options during your lunch break. Or go for a wander around a really

cool market and pick up something nice for dinner on the way home. Or be able to start your day and sprint round the circle that surrounds the outside of the six acre Power Station. Or end your day in the river front park watching an outdoor movie projected on The Power Station.

We also know if we get the right people in to run the bars and restaurants at Battersea, to put on new plays and live music every night, to showcase the most up-and-coming artists, fashion designers and film-makers, then the night-time offer will be so attractive people will make a beeline for Battersea after work no matter where they work or live.

Working+ is about building trust and camaraderie among our business community and this will only happen with the right offer both inside and outside the office.

**FACT:**

According to Bupa, six million people do not take a lunch break and only 13% of the workforce takes a full hour away from their desk.



*Wouldn't  
it be great  
to have a lively  
neighbourhood on  
my office's doorstep?*

## 30. Unique address

Sometimes it's a given. Park Lane. Mayfair.  
Sometimes it's created. Canary Wharf. Broadgate.  
Sometimes it happens out in the sticks. Stockley Park. Silicon Valley.

But companies look long and hard at what an address can offer them, over and above just the location itself. If it has the right associations for their line of business, they are more likely to do well being based there.

Simple as that.

The Power Station already stands tall, four chimneys tall to be precise. Visible on the London skyline from all over the city. An icon known the world over. For the companies that choose to locate in The Power Station, soon enough they will become associated with The Power Station's brand cachet because synergy creates a significant premium, particularly in relation to the built environment, such as the O<sub>2</sub> Arena and the Emirates Stadium in London. And they will never have to travel to a meeting because when the person at the other end of the phone hears they can have a meeting inside The Power Station, they'll always come to you. This address will be the new benchmark. Mark our word.







*I have to be here, now!*

# LIVING



# there's no place like home

In the UK we're often accused of being obsessed with house prices and thinking of residential property as a financial investment.

But the development world must not lose sight of the real goal – creating wonderful, liveable homes in much-loved neighbourhoods.

Ranked according to their quality of living, interestingly it's the same list of cities that always come out on top in global surveys. Typically old-style Europe (Helsinki, Vienna, Zurich and Copenhagen) are followed closely by Vancouver, Auckland and Melbourne. Zurich is also ranked seventh most expensive city in the world to live. So is it a case of: you get what you pay for. Not necessarily. London was recently ranked 25th as far as cost of living goes, but only 38th in terms of quality of living. It would seem that Britain's capital has a bit of work to do.

On the face of it, there's nothing much missing from London's offer – it's a vibrant, vital place to be, with plenty of green space, great eating out, good public transport, fabulous shopping streets and markets, plus a night-time entertainment scene that is the envy of all but a handful of other places round the world.

*Illustrations: Sally Lewis*

Take London: who are the people  
that want or need to live here?  
What kinds of lives do they lead?

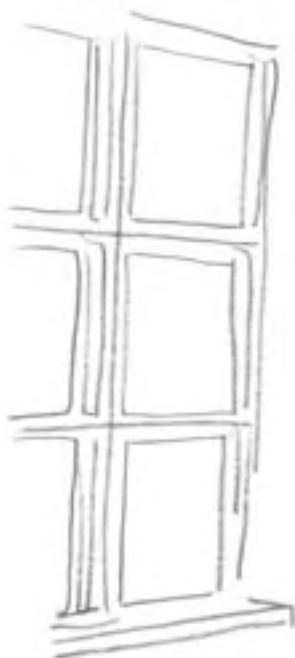

It's clear the picture is changing.  
People are living longer and  
having children later in life.  
Urban demographics are rapidly  
changing. Between 2001 and  
2009 London's population  
grew by over 430,000, which  
was more than any other region  
in the UK.



But on the living front, London doesn't quite deliver.

The quality of people's homes is variable; so too are some of its neighbourhoods. Some would question whether parts of London can even be called neighbourhoods, as they don't have the sort of coherent, characterful identity that the term presupposes.

## THE BUSINESS OF LIVING

Why is this? Part of the answer lies in the way homes are built in the UK and the tendency to think about them only as 'residential developments', meaning that quality of living is determined – and to some extent neglected by – the ups and downs of the housing market, which in turn has been driving thinking and behaviour for decades.

There are signs, though, that things are changing and it's not just a temporary effect of the last recession. The average age of the first time buyer in the UK has now risen to 39 years old. Whilst property in London has always been relatively more expensive, the average London home now costs 113% more than the average across England and Wales, making it even harder for people to get on the property ladder in the capital than ever before.

Even if the stakes have risen higher, it's still the responsibility of those who build homes in London to make sure they also create the opportunity for a good quality of life. Those lucky enough to have a large disposable income have always had plenty of choice about where to live. But they're not usually the ones who create urban buzz and multi-cultural texture that go towards quality of life. So it goes without saying that a good London neighbourhood needs to offer anyone the scope to build a fulfilling urban life around their family, their interests, their friends and their work and make it all balance.

In searching for somewhere to call home, everyone is looking for the best match they can achieve between their dreams and reality, where reality is determined by considerations such as journey time to work, access to local schools and other facilities and, of course, price. For most people, this best match is therefore a compromise offset by a few little perks – a park round the corner, an active residents' association, a local butcher.

Meanwhile, in a new bottom-up neighbourhood-orientated era that has dispensed with hard and fast housing targets, Government and local authorities are looking for an ingenious trade-off between reduced public sector spending power and the pressing need for more homes. The volume housebuilders are responding to new initiatives, but much more cautiously, not least because financing property development has got a lot tougher. Inevitably, delivering homes that will also enhance people's quality of living is an increasingly difficult goal to achieve, but it must remain a goal.

## THE CHANGING CONCEPT OF 'HOME'

So, what is the right response to this situation? The big changes taking place in terms of planning, financing, constructing, selling and letting homes, lead many commentators to identify this time as a key moment to rethink what people really want from urban living and to seek out other ways of making it work. In the process, the concept of home per se is likely to be radically overhauled.

Some things to consider. Who are the people wanting or needing to live in London? What kinds of lives do they lead today? It's clear the picture is changing. People are living much longer and having children much later in life. Urban demographics are rapidly changing: only 25% of London households are 'nuclear' families. Around 30% of them are pensioners and 85% of the growth in household numbers over the past 20 years is down to more people living alone. The housing market needs to build a greater variety of different types of homes, but not simply in clumps of single user-type communities. More homes are needed for 'empty nesters' – older people trading down from large family houses, for separated parents who have the kids coming to stay at the weekend, for boomerang families whose kids have moved back home after college and for professional sharers wanting to team up to get on the housing ladder.

A revised concept of home also needs to take into account shifting attitudes to work and technology. Our social lives might revolve around laptops, mobile phones and the internet, but we are nonetheless more aware of our impact on the environment and want to adapt our lives to be more ecological without a huge effort on our part.

# Strategic thinking: Living

## HABITAT

A mature community in nature comprises all the species that can happily co-exist without fighting for the supply of food, water or a place to build a nest, den, lair or burrow.

Only when there is an abundant and lush habitat available with many different kinds of trees and plants, is biodiversity achieved and the most sophisticated creatures thrive.

## HABITAT CHART

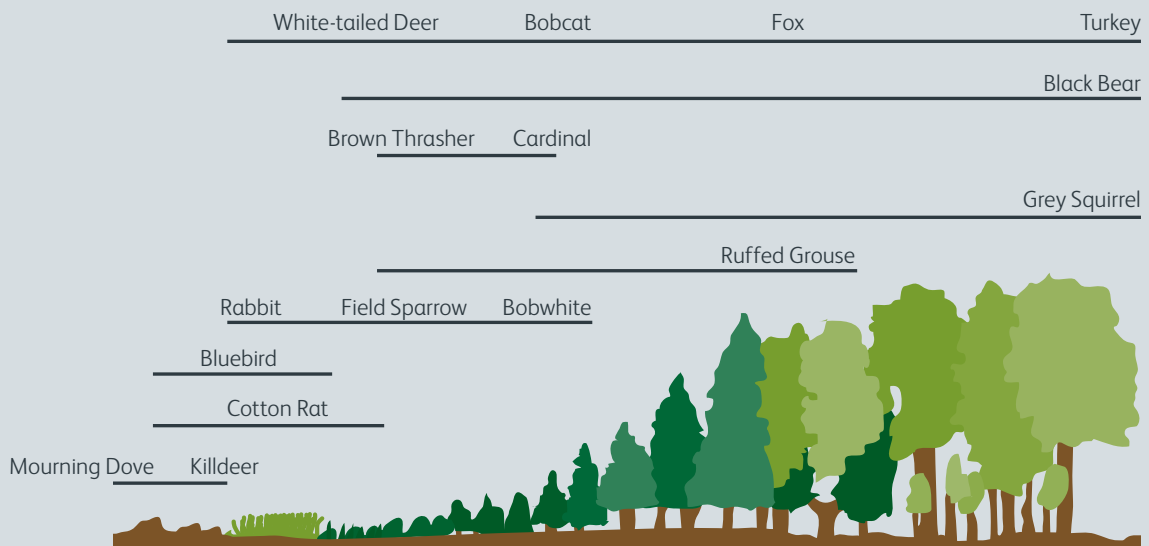

Age in years		1	2	3-20	25-100	150+
Community Type	Bare Field	Grassland	Grass-shrub	Pine Forest	Oak-Hickory Forest	

## **ADAPTABILITY & GROWTH**

The overarching theme in response to these changing circumstances and outlooks is adaptability – a quality which is all too often absent from new homes on the market in the UK.

The future is inevitably about urban living – and there are proven benefits: people living in cities have been shown to achieve greater success in the workplace and levels of educational attainment, quite apart from the fact that as a virtue of living where they do, they also have a greatly reduced carbon footprint.

But the qualitative benefits are always challenged by the need for quantity: estimates suggest that London will need to accommodate one million additional people over the next 20 years, which equates to around 700,000 new homes.

With the green belt still in place, this has to be achieved without extending beyond the city boundaries, through the creation of adaptable contemporary neighbourhoods, be they in central or peripheral locations, neighbourhoods that measure up to the very best in Europe, such as those found in Zurich, Copenhagen and in the smaller cities of Freiburg and Malmö.

It can be done: London has a surprisingly low population density, with just 78 people per hectare, compared with around 300 in Paris, and over 500 in Barcelona, which indicates our capital can be intensified whilst still enhancing quality of life. Making a city denser means there is more happening per hectare and places are better able to support a truly local economy, where people can work close to home and find most things on their doorstep.

## **LIFESTYLE VS. LIVEABILITY**

The term ‘lifestyle’ now seems a bit hackneyed. It was coined by Alfred Adler, an Austrian psychologist, in 1929 to describe the way a person chooses to live. It acquired a broader more sociological meaning in the 1960s, when it was used to categorise sets of behaviours adopted by different groups of consumers. From then on it gradually found its way into the language of politics, publishing and marketing.

Everywhere you look now there are examples of property marketing depicting images of well-groomed couples with great teeth, smiling and drinking wine on their trendy sofas, now the standard way of portraying an aspirational lifestyle in brochures and on hoardings. Such images have in effect codified the way people see themselves and has both raised and dampened expectations. Lifestyle as a notion has therefore come to seem not merely aspirational, but passive and ultimately clichéd. It is in danger therefore of failing to capture or speak to what really drives people’s hopes and desires where living is concerned, like making lasting friendships, creating something of value and participating more fully.

By contrast, the emerging notion of liveability seems more productive, describing an attribute of place and its inherent potential rather than a codified mode of living. Liveability is pragmatic and everyday and deals with urban lives in their complexity, rather than trying to reduce them down to a few glossy images. Liveability allows a neighbourhood to be thought of as a series of interconnected systems and spaces, that organised well can enhance enjoyment and ease of living, from growing food on the rooftops right down to waste disposal and underground drainage.

Paying this kind of close attention to the living environment pays off in the long run, not least because it is key to establishing a real sense of a neighbourhood that people will value and enjoy and that serves to connect the interior private world of the home through to the public spaces beyond.

When someone buys a home it is the biggest investment in place they make in their life. It’s more than just somewhere to live. In looking for a home they are responding to a pressing need for a sense of belonging and a means to establish identity for themselves. It’s a perennial challenge.

Battersea Power Station will lead the way in providing some fresh solutions.

## 31. Different as standard

Living at the Barbican in London is not to everyone's taste – for some it's brutal and unrelenting – but the people who live there love it. In fact, they love it so much that many of them move to a different apartment within the development as their life circumstances change, rather than go elsewhere. And while the influx of new developments within the City of London will challenge the Barbican, many of its first principles still hold merit today.

This is only possible because of the huge variety of flats the Barbican has to offer and is one of the reasons it has held its value as one of London's most desirable developments. Today, most new developments tend to value engineer this down to just a handful of unit types and, in an effort to make a quick sale, miss out on this long-term value.

*We're all individuals so why do they give us all the same?*





We think great neighbourhoods come about when you have a mix of people at all lifestages and this only happens if you provide them all with somewhere suitable to call home. Students, couples, all kinds of families, as well as older people. To all live in one place, these individuals need student accommodation, microflats and studios, apartments in a range of sizes, lifetime homes, duplexes, triplexes, penthouses, rental and serviced apartments – something to cater for all budgets and tastes.

Because when it comes to home, not everyone's the same.

And when things change in your life, should you really have to move somewhere completely different because there isn't a home close by that meets your needs?

Should you really have to wave goodbye to your neighbours? Increase your commute? Change your doctor and dentist? Find a new nursery or school for your kids?

Not unless you want to.



**FACT:**

Of the 2,014 flats that were originally built at the Barbican, there were over 100 different layouts available.



*Whatever happened to homes with some personality?*

## 32. Expect the unexpected

There was a joke doing the rounds a while ago: 'Did you hear about the village idiot who bought a house and converted it into a barn?'

This might make you smile – but it only works because we all think it's quite normal to dream of making a dream home in a disused agricultural building. And how funny is that?

When you think about it, this doesn't reflect well on those who build new homes. Today's new build properties are often so characterless, it's as if the designers forgot that people might actually want to enjoy living there. Is it really the case that only refurbished buildings – or even older properties in general – can be characterful?

With people increasingly working from home, there is now an even greater need to create an interior world that can support, stimulate and surprise its inhabitants – and there are lots of ways we can achieve this.

Mindful of those converted barns, our designers are being asked to put in split levels, high ceilings, double height spaces with galleries, even winter gardens you can use throughout the year.

Ah, you might say, that's great but what about the smaller units?

The truth is, it can work at that scale too, but it takes more skill and a certain kind of bloody-mindedness to get the details right. Like making sure as many flats have a fantastic view of The Power Station or the River Thames as possible. And that the view can be seen through floor to ceiling windows. And it just happens to be revealed the moment you open your front door.

Welcome home.

### **FACT:**

A RIBA survey found that nearly one in three people would not consider buying a home built in the last ten years, or would only consider it as a last resort. Of these, 60% said it was because the rooms are too small, 46% said they lack style and 45% were concerned about the lack of outside space.



## 33. Experience life

Danish people have this great concept – ‘hygge’ – which is almost impossible for non-Danes to pronounce and only slightly easier to understand. Roughly translated it means ‘cosy’, but in practice it is far more than that – it’s the sense of wellbeing that comes from sharing an intimate setting. Think of it as the contentment you feel sitting around a fireplace with friends on a winter’s evening. Or wandering barefoot through your apartment in the morning with a hot mug of tea back to the comfort of your bed. That’s ‘hygge’ for you – and isn’t it great someone has given it a name.

The trouble is, it’s very difficult to communicate through drawings – and the moment you label a set of floor plans with the words ‘living room’, ‘bedroom’, ‘kitchen’ and ‘bathroom’, they become just that – generic labelled spaces.

Take the bathroom: think about taking an invigorating morning shower after a run, or a soothing evening bath, with dimmed lights, candles and music, after a long, hard day. We need to make sure that people can have experiences that transform that space where someone wrote ‘bathroom’ into something much, much more.

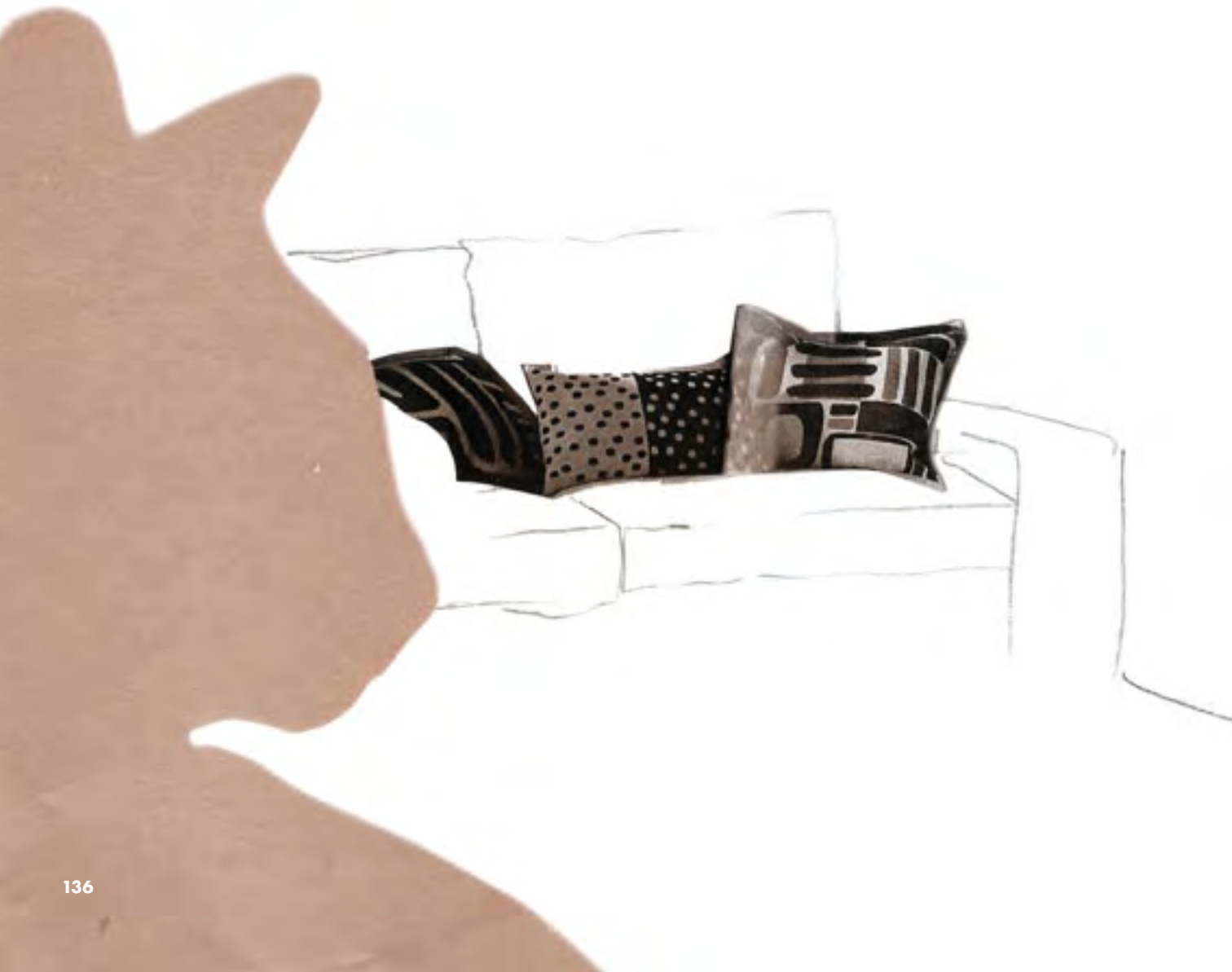

It's the same for kitchens. Most marketing brochures show shiny clear surfaces with just a fancy lemon squeezer on the side. Appealing for sure, but we shouldn't lose sight of these as spaces that are at their most creative when there are pots and pans stacked high in the sink, to produce a lovingly-cooked meal for friends and family.

We think people should be able to feel 'hygge' every day – bedrooms that are designed for sleep, sanctuary and seduction (steady), living spaces that are not just focused on the TV and homeworking areas that appear from nowhere, then disappear into the background when it's time to relax.

So we all need to remember that good interior design is not just about how spaces look, it's about what they let us do and how they make us feel.

**FACT:**

The kitchen has doubled in size since the 1920s. People spend on average 2 hours per day in their kitchen compared to 1.5 hours in their living room.

*Bathing not bathrooms, cooking not kitchens.*

## 34. A place of my own

It's fascinating going into other people's homes isn't it? Seeing how completely different they are, all the different layouts, colours, furnishings and fittings that tell you something about the personal taste and life of their inhabitants.

So why are the interiors of a great many new homes so bland? Sadly, in an effort to appeal to most people, developers often do the least exciting thing and paint them magnolia.

Does it have to be that way? When you move in, shouldn't everything already be just as you want it – just like you can customise pretty much everything else you buy nowadays: computers, cars, trainers, T-shirts – you name it. We live in a world of bespoke consumer products, so why aren't we past the Model 'T' Ford approach of 'any colour as long as it's black' in housing design?

Our aim at Battersea is to allow you to move into anything from a fully finished and furnished apartment, to an empty shell where you get to design a completely bespoke interior. You could, if you want, buy two units and knock them into one. No problem. Because we're making sure the structure and services allow for this. We're also experimenting with pods – where your kitchens and bathrooms are assembled in a specialist fabrication unit, so that when they're finished they are absolutely perfect and come in every possible configuration. You choose just what you want. And it won't stop there: wall finishes, flooring, tiles, doors – there are lots more decisions you get to make.

Unless of course you want to leave it to us. But just bear one thing in mind, this is Battersea Power Station – we don't do magnolia.

**FACT:**

There are over 10 million customised configurations to choose from when purchasing a Mini Cooper.

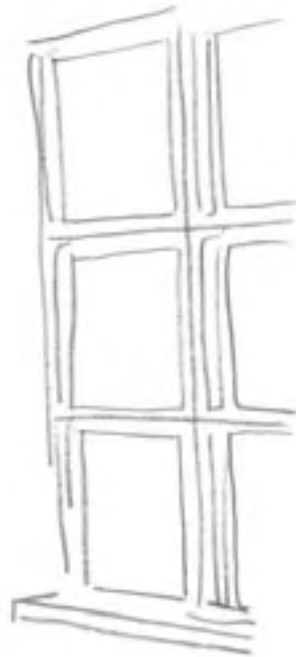

*I don't want a flat, I want a home.*



*To the left or right?*

*Up or down?*

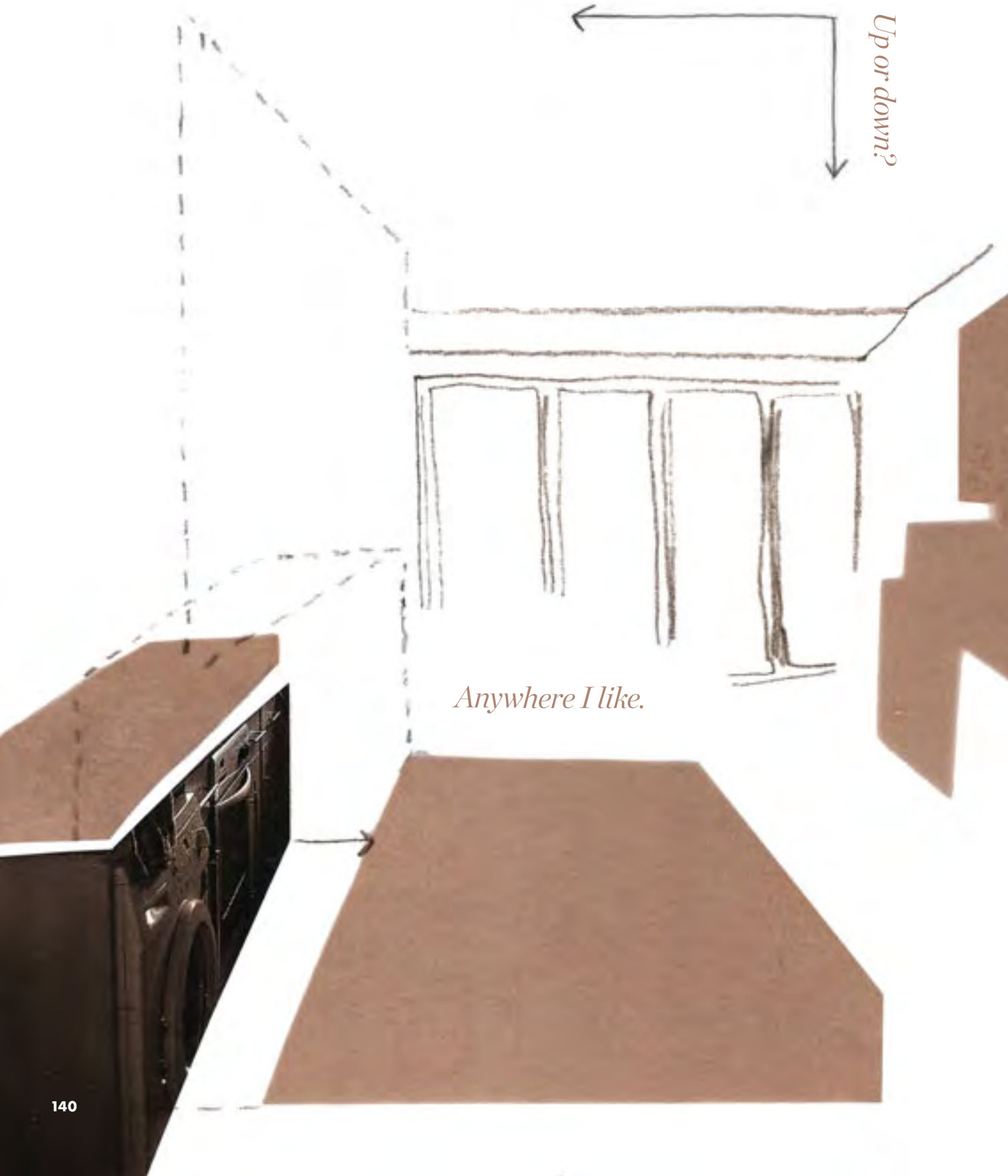

*Anywhere I like.*



## 35. Transformation

We've all been there. The big family meal, everyone elbow to elbow round an extended table with someone on a piano stool. Impromptu, a bit makeshift maybe and with overcooked vegetables for sure – but it is these events that live on in our memory and fill our photo albums.

Our homes should make this kind of thing easier, they shouldn't stop us from doing things that add richness and enjoyment to our lives – inviting a friend over for the weekend, celebrating a special occasion, hosting a meeting at home, displaying an amazing new painting, impressing a potential lover or even just changing the furniture around – all this should be possible even with a one-bedroom apartment.

It's about being able to reformat the space you have – very few city dwellers can afford to have dedicated space large enough for all these things – we need to think carefully about ideas for transforming spaces in an instant to serve other purposes, so we can do what we want more easily.

At a typical Battersea apartment, we're making spaces that can be open or closed, with clever sliding partitions to let people change the shape of their living space.

We're connecting these spaces better to the outside with big openings to balconies and winter gardens. We're trying to make it so every room can be arranged in at least two ways and we're keeping stretches of wall space clear so you can put up any number of shelves and pictures. And we're making sure you'll be able to turn the lighting up or down to suit your mood.

It's going the extra mile beyond what counts as a Lifetime Home,

So you'll want to stay,  
In the place you love,  
For as long as you like.

### **FACT:**

The famous De Stijl-influenced Rietveld Schröder House in Utrecht, designed by Gerrit Rietveld in 1924, had an innovative open plan with bathroom and sleeping areas screened off with sliding walls.

Mrs Schröder brought up her three children in it and continued living there until the day she died in 1985.

## 36. Deal with my crap!

Remember all those science fiction films – the ones that imagined how life would be in the year 2000? Everything was white and streamlined, we'd all have a personal robot to do our housework and there would be no stuff – as if magically all our clutter would be gone and we'd be able to lead a more tranquil life.

Well things haven't quite turned out that way (we never did get those flying cars) – instead of less stuff we all seem to have more and our homes are struggling to cope: take a look at the bulging cupboards and overstuffed wardrobes. And it doesn't stop there. There's over 40 million sq ft of self storage floor space across the UK – which is where our stuff goes to live when we run out of room – and it's no cheap solution! So it's no surprise that lack of storage space is a major complaint from people buying new homes – show flats are made to sell and storage just isn't sexy.

But we don't think this is right, so we've thought this through from first principles.

### **FACT:**

36% of people say that clutter in their household is such an issue that they avoid coming home to relax – because they don't know where to start cleaning.

In essence, we need space for:

- *things we can't dump but never use (heirlooms and old furniture);*
- *things we use but only when the time is right (skis and deckchairs);*
- *things that are useful but ugly (ironing boards and hoovers);*
- *things we can't survive without (clothes and food);*
- *things we'd like people to see as long as they're neat (books and ornaments).*

All of these *things* need to be stored in completely different ways – which makes you wonder in most new apartments why you get just the one deep dark cupboard.

By providing all kinds of storage – including some lateral solutions to stuff like streaming media content and off-site back-up of digital storage – everyone will be able to live more easily with their stuff. Maybe that clutter-free future could happen after all.



*Where does it all come from?*

*Where can it all go?*



## 37. Living+

What would really make a difference to your home life? More time? More fun?

More access to the good things in life?

More time seems to be top of most people's list. We all seem to have more and more to do and less and less time to do it in – so we need a strategy at The Power Station to give everyone a hand.

Let's start with a concierge who knows you by name – they could receive your packages, deal with your dry cleaning and sign for your supermarket shop when you're not there. Does that sound good?

Then how about a team of trusted people you can call upon to do your cleaning, odd jobs, or painting and decorating? Well, all this will be available on demand plus, if you like, IT support, valet parking, even room service.

Job done.

Now if it's fun you're after, but you don't really want to go out, then maybe we can bring it closer to home. Like the resident's lounge and bar for meeting your friends – it's on the waterfront, with an amazing view.

Gym, swimming pool and all that – a two minute jog downstairs (so no excuses). There's even a space just off the lobby you can hire for your child's birthday party or rooms your family can use when they come to visit you over Christmas.

In a hotel it's the concierge's job to know what's on and how to get last minute tickets for guests. That's what we want to give our Battersea residents, not just the visitors who are staying in our hotel for a few nights.

Our residents will automatically be the first to hear about the private views, one-off concerts, parties, club nights and fashion shows all happening at The Power Station. They'll be able to get special advance booking for the theatres and music venues or get a table in their favourite restaurant at short notice, because they live here and it's their place.

That's what we mean by living+.

### **FACT:**

A Royal Mail survey found that after moving into new homes, 74% of residents experience problems ordering goods and services.

So much to do, so little time to do it.

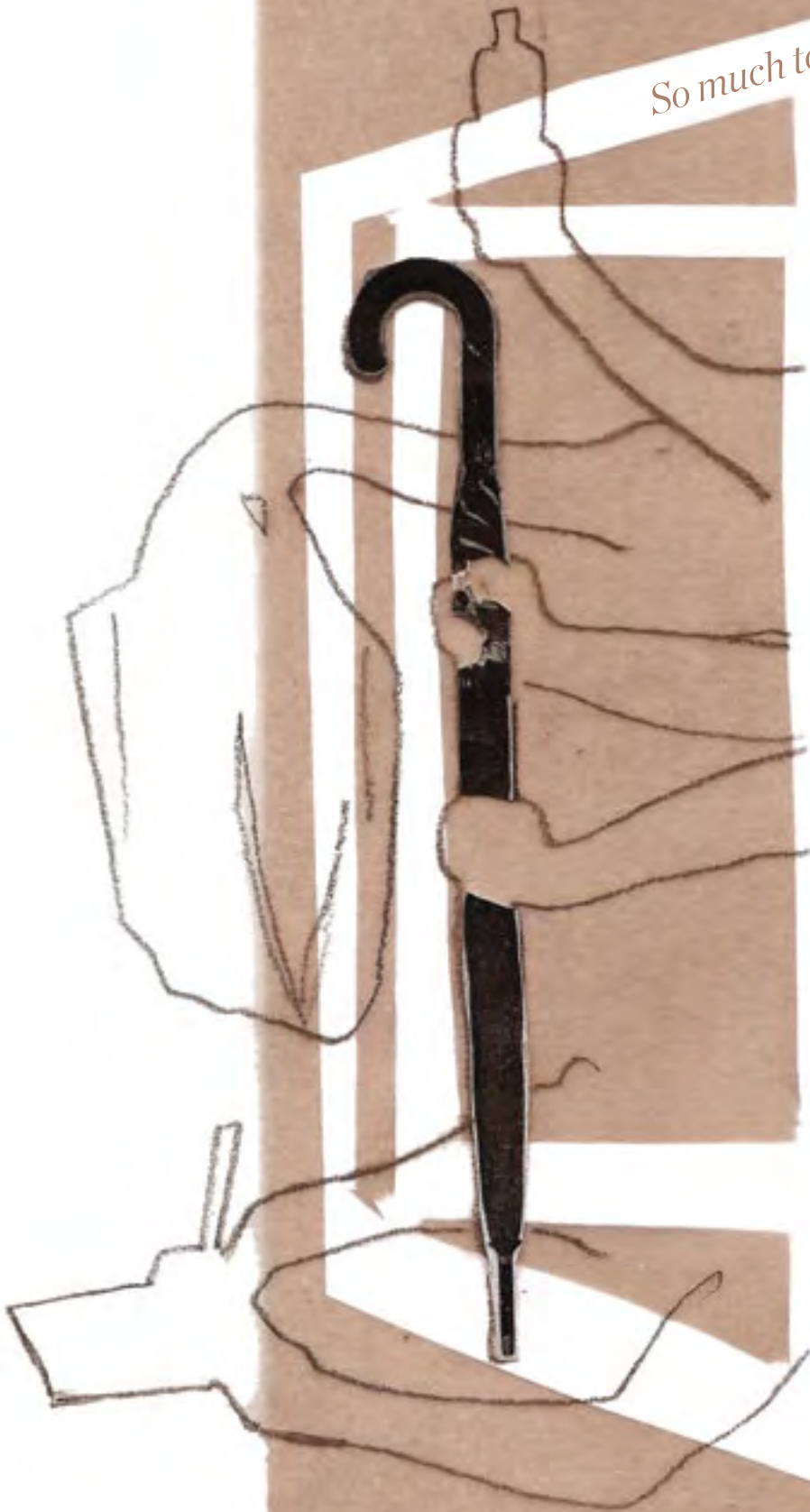

## 38. Meet the neighbours

With over 90% of us living in urban areas in the UK, it's more than likely you're sitting reading this in a big town or a city. Look around you – it might seem cosmopolitan, but sometimes it can be a bit impersonal.

City dwellers like the anonymity, but admit it's nice when on the odd occasion someone they have never spoken to before suddenly strikes up a conversation.

It's fleeting and inconsequential, but it puts a smile on your face when it happens and reminds you that life is not always about big plans or deadlines, it's also about enjoying little moments with others.

So why is it that the closer we live to each other, the less we seem to interact? Surely living in the city and knowing your neighbours don't have to be mutually exclusive?

*We see each other every day,*



To address this, at Battersea we're creating spaces where those 'over the garden wall' conversations can start to happen and people can share a friendly moment before going inside their homes.

It means being a bit more generous with our corridors and lobbies, so people will want to linger.

It means providing sofas or art in the entrance halls, to help people slow down and chat; and shared facilities like gyms, clubhouses and business spaces, where residents come into contact with other people living in their building.

We want our residents to call 'the people next door' their neighbours – so they could ask each other to water plants, borrow tools, or mind the dog. Because real neighbourhoods need real neighbours.

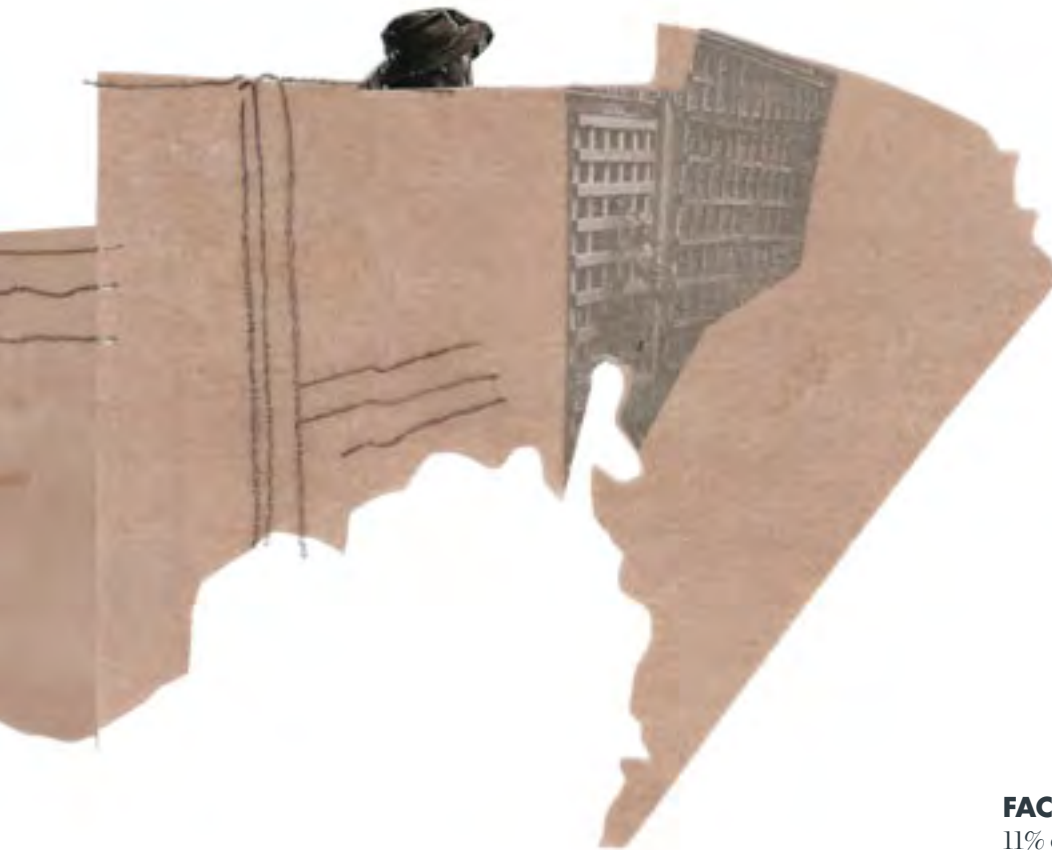

*I really should know their name.*

**FACT:**

11% of Londoners cannot name a single one of their neighbours and half of UK adults agree they know more about the lives of their favourite celebrity than the people they live next to.

## 39. Clear conscience

Whatever the scientific arguments, we all feel we could do more to tread a bit lighter on this fair earth. But the problem is, when we try to be more sustainable, things seem to conspire against us, and even with the best intentions we feel guilty. Guilty that we've thrown away things we know we should be able to recycle, or that we've come home to discover the lights have been left on all day, or taken the car because you still haven't got round to mending your bike's flat tyre.



*It shouldn't be so hard to do my bit for the environment.*



But you know it isn't always your fault – the problem is that most of us live in places that just weren't designed to make being sustainable in any way convenient.

What if we'd thought all this through at Battersea? What if your home was really energy efficient and your bills were lower? What if all your appliances didn't use much water – but you still get the best shower you had ever had? What if recycling bins were built into your kitchen and you didn't have to trip over bottles and newspapers anymore?

Add to that living somewhere with a new Underground station, two railway stations, several bus routes – so you wouldn't even need a car or, if you did, you could just join our car club.

No depreciation, no road tax, no annual service, no congestion charge – but always there when you needed it.

And what if we made your bike an easy option, accessible and stored out of the rain. Better still, you can just walk, because Battersea is a complete eco-neighbourhood with everything you need on your doorstep.

At Battersea you'll get all this, plus your home would be powered by the world's largest carbon neutral building.

Green? Definitely. Guilty? Not a chance.



**FACT:**

Findings from the most recent National Geographic and GlobeScan Greendex Survey, which measures environmentally sustainable consumption at a national level, found a quarter of British people would not describe themselves 'as green but plan to be in five years'.

# LEARNING



# hungry for knowledge

At Battersea, we offer opportunities for people not just to live, work and play, but to grow. Growing involves learning something new about the world or about yourself, and is something that every city neighbourhood should make possible.

*Illustrations: Georgina Bing Han*

It is a proven fact that the pursuit of learning also helps people to respond positively to changes in their environment and circumstances, to remain engaged in society and be more physically and mentally active. Typically however, formal learning ends when a person leaves full-time education. Beyond that point, people tend to dip in and out of education during their adult life, in order to acquire the skills they need in the workplace. But this limits us to learning only that which is deemed necessary. Ideally, learning is more than just a means to an end – it's something that combines purpose and pleasure, something that is enjoyed in formal and informal settings, providing a lifelong experience of enhancement and enrichment to our daily lives.

Lifelong learning isn't something new: the British Institute of Adult Education was set up in London almost a century ago. This is the organisation that also helped create the British Film Institute and the Arts Council. Now called the National Institute of Adult Continuing Education (NIACE), it continues 'to encourage all adults to engage in learning of all kinds'.

# It's projected that 90% of all jobs will require digital skills, yet there are more than 7 million adults in the UK who have never used the internet.

Equally, The School of Life, from whom we took advice, has dedicated itself to helping adults stay engaged in a constant self-learning journey. Responding to the steady rise in DIY/self-improvement knowledge seekers who are hungry to learn, The School of Life set up shop in London on Marchmont Street in 2008, offering classes covering unconventional topics such as 'How to have Better Conversations' and 'How to be Confident'; while other ground-breaking organisations like TED, whose mission is spreading ideas, have satisfied people's desires for both online and offline learning all over the world. TED's Talks videos recently surpassed 1 billion views online, and through its conference series TEDx, has engaged 800,000 people in 1,300 towns in cities across 134 countries. These are the kind of attitudes to new forms of learning we want to foster at Battersea, making it a place that is synonymous with the cutting edge of education. How we get to this place will take some forward thinking that will address the needs of a multitude of audiences and an approach that sees the entire site as a place for learning.

## LEARNING SPACE

So what is a classroom these days, given the wealth of access to media, platforms and ideas we're faced with? With modes of learning ever-changing, educational settings constantly need to diversify in order to be challenging, sociable and fit for purpose, from the early years end of the spectrum right through to higher education and executive training programmes.

Britain has enjoyed a long history at the forefront of educational innovation and its educational systems have long been studied and copied by many other nations. But as other nations introduce their own

styles of teaching and learning, there is no room for complacency in the UK – there is still enormous scope to produce more effective contexts for learning that are closer to a real life situation for the learner, so that their new-found understanding can be implemented and reflected on.

The trick with any learning environment these days is to get the balance right between multi-purpose and specific, whether as a laboratory, studio or otherwise. Learning is now also more active, experiential and collaborative, so it makes sense for there to be as many different ways for this to take place outside the classroom as inside, whether physically or vicariously. Advances in information technology have led to countless opportunities for interactive online learning, where it is possible to visit museum collections and archives on the other side of the world, or do multi-player maths games with students in another time zone. Indeed, most schools and universities now make active use of virtual learning environments (VLEs) of one sort or another, to augment study and achieve a blend of independent learning, effective group work and face-to-face contact time.

But even the best VLE is often only making up for the fact that it's often difficult and less productive to visit a place in actuality, especially if you have a class of 30 students and only a few teachers. A place like Battersea needs to take care of all the risk assessments and health and safety regulations, making school visits as easy to organise as a classroom-based activity, thereby assisting ambitious teachers by offering experiences that are not only safe, but also to address several aspects of the curriculum simultaneously to make them truly worthwhile.

To learn more ourselves, we also spoke to the Director of Ravensbourne, Sir Robin Baker, who'd moved his whole art college from the depths of suburbia to a new and distinctly anti-institutional building beside the O<sub>2</sub>. Lectures take place within the new building which has few partitions – as such the open plan nature of the interior lends itself to casual participation as well as focused attendance, while allowing students across different courses the opportunity for regular interaction.

We want to be operating at the forefront where these kinds of learning-orientated issues are concerned, making Battersea a sure-fire educational powerhouse of stimulating and integrated study programmes and opportunities, that people of all ages can benefit from.

In short, we plan to achieve top marks at Battersea, to learn from other projects and to fulfil the inherent potential of the place to be a new generator of ideas, thinking, learning and teaching, both directly and indirectly by ensuring we have a state of the art learning environment.

## **LEARNING PLACE – INSPIRING & DYNAMIC**

In order to attract tomorrow's business leaders and help them conceive their best ideas and motivate their teams to implement them, we need more than a few acres of contract carpet and stackable chairs. We are looking at what constitutes a cutting edge bookable think-tank environment – where people are instantly at their ease and firing on all cylinders.

We've all seen a great presentation ruined when the technology lets you down and knocks someone's confidence. At Battersea we need people to see, hear, share and showcase their work to whoever is in the room and anyone else joining them from elsewhere in the world, via the latest communications technology with support staff making it all go seamlessly.

The built environment doesn't have to be static and with the right approach to moveable components and facilities management, an effective conference venue can extend its capacity to support meetings, events and workshops that really suit the user, with the right break-out rooms and the right proximity to good food and drink, as well as access to other business services.

Getting this combination just right will be critical to creating an innovative and inspiring learning environment.

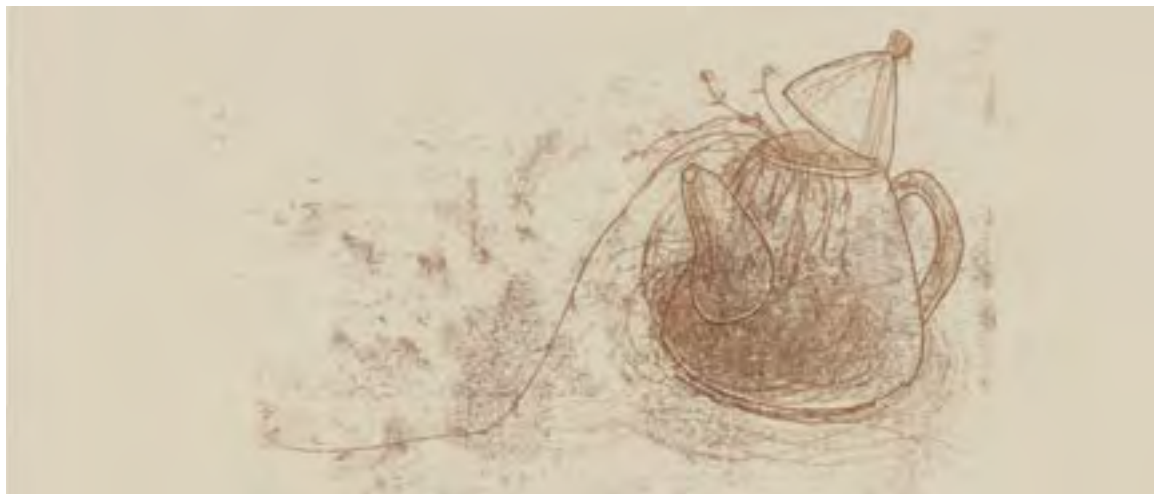

# Strategic thinking: Learning

In a sophisticated world in which personal development and self-actualisation are becoming increasingly important, the Battersea response is to look for learning opportunities in all aspects of the place offer. From more traditionally direct provision (education and conference facilities, workplace learning, internships and apprenticeships) to more ambient approaches, which add educational aspects to retail and leisure.

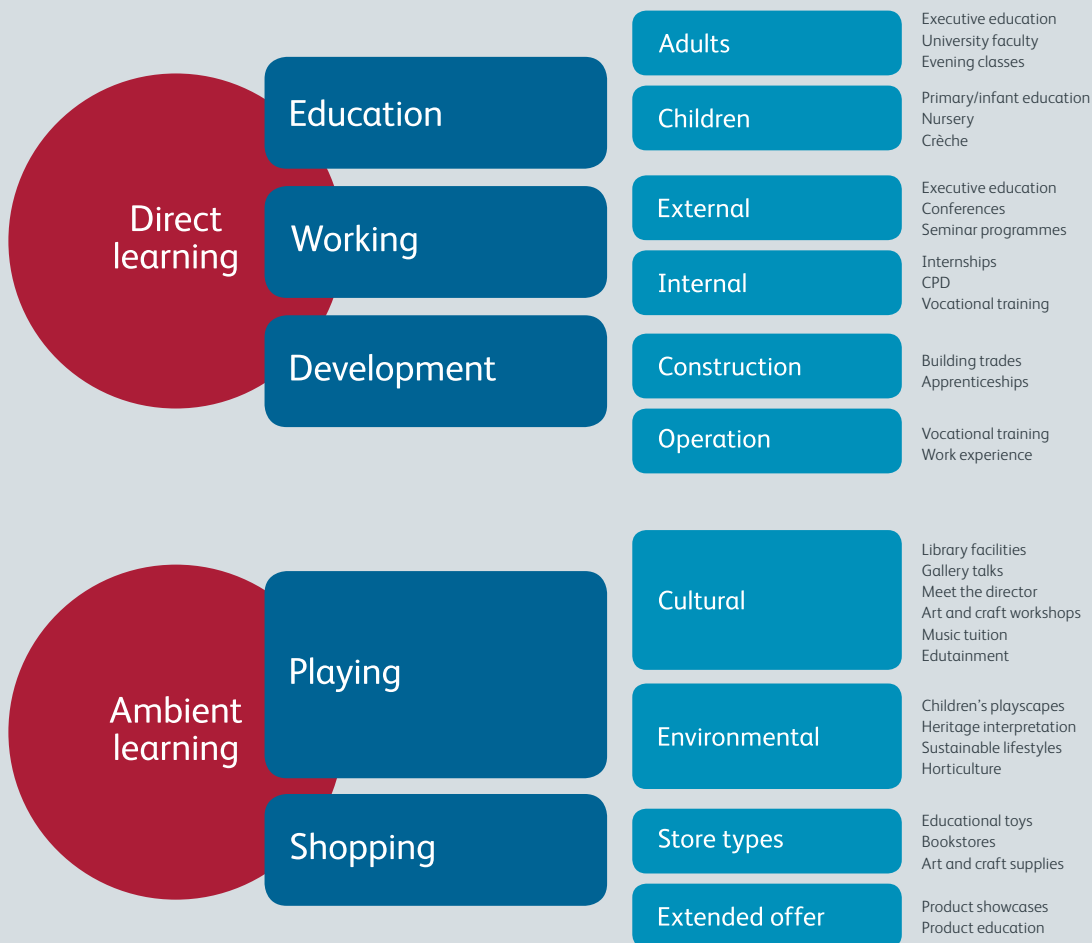

## LEARNING LIFE

For some, Battersea's learning potential will simply offer an informative guided tour that will take you behind the scenes, or explain to you some of its innovations in more detail – delegations from China and Russia coming over to see the sustainable credentials in action, visitors from Australia and Canada wanting to reinvent their own early years provision. School trips from France and Germany to see London's newest heritage landmark. It won't matter what they're studying or at what level – history, geography, business studies, cultural studies, politics, economics, theatre studies, music, fashion, art, environmental science, architecture, planning – there will be something here for everyone, because Battersea integrates its activities on every level.

## TRAINING & RESKILLING

But learning is not just about studying for its own sake, to know more, it's about making yourself employable in the long term. It's quite astounding to note that in the EU, 24% of the low skilled population is at risk of poverty, lacking the necessary key skills to be able to flourish in today's world. That's why the employability aspect of learning will play a vital role in Battersea's learning offer. Under learning we are putting together a comprehensive programme for the re-employment of highly capable but out-of-work Londoners.

Battersea's job shop is as important as all the other learning components, because we don't just point people towards our available construction jobs, we take them under our wing offering a training scheme that matches their growing qualifications with the right roles, as they help to transform Battersea.

All in all, we anticipate that we will be involved in creating over 15,000 new job and training opportunities for local people. Alongside this, our graduate centre will help recent graduates achieve a smooth transition from their degree programme into the real world, showcasing their work and coming into contact with a client base they would not otherwise have been able to network with.

Then there's how learning can help us operate more fully as citizens. The KnowledgeWorks Foundation talk about our needs as 'educitizens' – that is to say our rights as learners to help re-create civic life. Learning that lets us redefine how to play our part in today's society needs to be open-source and cooperative, enabling people to speak up and become more self-governing. At Battersea, we are responding to this unique challenge by developing groundbreaking new roles and associated professional development programmes for all our staff, from our place director and management team through to our 'play rangers', education officers and business centre team. Operationally, our aim is to engender a new attitude to the governance of an urban quarter, going beyond the current role and remit of a business improvement district (BID).

In its simplest terms, learning can be fostered by having somewhere quiet to go and think, read, listen, talk, test and rehearse. That's where Library 2.0, our community hub, comes in. We'll work with Wandsworth to go one better than the IdeaStore found in other London boroughs. Libraries are being rebranded and reinvented all over the world and we want to have the best example here at Battersea. Technologically savvy and forward facing, it's also somewhere that adults who have never used the internet can come to get online and become an active and vital player in the growing Nine Elms community.

All in all, Battersea Power Station will demonstrate that learning can take place everywhere and be accessed by anybody – as easily as the air we breathe – and every bit as good for our health.

## 40. Crèche+



You know how it is.

Really, you need to work late, but the nursery near your home closes at six, so instead you have to go early and rush back across town to get there in time. At the mercy of public transport and roadworks, you arrive sweaty and stressed to pick up the smiling child you've missed all day. Where's the joy in that?

Sometimes you can get by without childcare, working from home while the little one naps, but there are those weekly meetings to fit in, when you need some help and you don't want to rely on your friend or neighbour, again.



**FACT:**

A study conducted by Bright Horizons found that 88% of people surveyed stated “because my employer sponsors a workplace nursery, I am able to maintain a healthy balance between my work and personal life.”

The crèche will be embedded in the new community at The Power Station and its staff will become friendly and familiar faces to you and your child. So while you attend your weekly Tuesday meeting, you’ll be safe in the knowledge your child is with people you know and trust. So we figure the blurb on the website should read something like this:

*‘Crèche+ is a five-star nursery concept, where flexibility is all and the level of care, attention, creativity and intellectual stimulation reaches the standards of excellence matched only by yourself as a parent... on those days when you’re not too tired and busy’.*

OK – maybe a bit less cheeky, but you get the gist.

And what about evenings? If you live at Battersea, we’ll be looking at running a babysitting service from the crèche too, so you can arrange for a trained nanny to come to your home and look after your child in the evening while you go out and treat yourself. It’s child’s play really.

Best of all, at the end of the day, your child comes home exhausted but with a big smile on their face.



*Around the clock childcare at my fingertips – are you kidding?*

**FACT:**

A survey conducted by the Association of Teachers and Lecturers found that 85% of those surveyed agreed that school trips can be one of the most valuable educational activities.

*Hold on,  
this is too interesting to be schoolwork!*



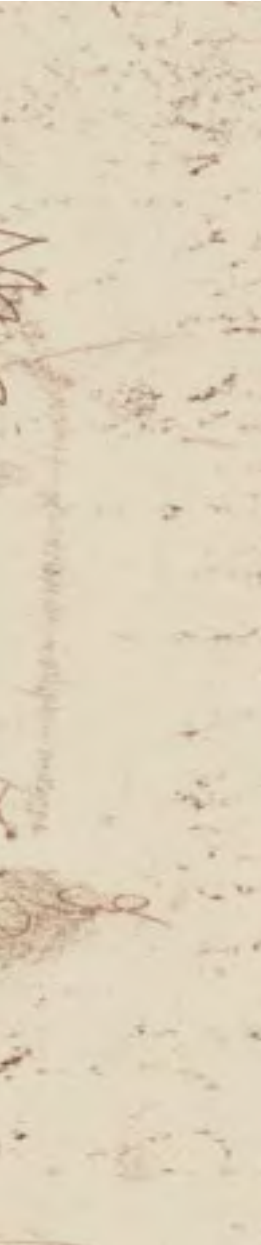

## 41. Learning landscape

It's an idea that's been around for a while – taking kids out of the classroom during lesson time to grow stuff, or look at nature – but the idea of a learning landscape, away from school, works just as well, if not better, at the scale of the city neighbourhood as it does in a playground.

We've got a whole lot of space at The Power Station and a myriad of opportunities for children to learn. We've got nature, the Thames, green energy and quite literally masses of industrial heritage. Then maybe up on the roof some state of the art weather station, air quality monitoring equipment and great views of railways, roads, flight paths and the whole of central London.

That's before we even begin to consider all the businesses and cultural facilities in and around The Power Station. So maybe your child will come on a class trip to the theatre, or a special screening in the cinema, hook up with one of the design studios, take part in events put on by our creative industries, or learn about food from a resident gastronome.

We're working on a better job description than 'education officer' for someone to oversee the lot, someone inventive and enthusiastic, who can take what's on offer at The Power Station and devise immersive learning experiences for school kids that teachers and parents could only dream of. And they'll be working out of the Discovery Centre of course, developing close working relationships with schools in Wandsworth and beyond.

And kids, here's the best bit – if we're clever and link it all into the National Curriculum – the grown-ups will have no excuses to stay away.

## 42. Local training

Local training is exactly what it says on the tin – offering opportunities to learn for people right on our doorstep. The Power Station is surrounded by residential communities and local businesses – who we know would like to learn new skills and improve the things they do without having to travel across town.

So whether that's a staff development programme, a vocational training programme, a youth enterprise scheme, an evening class, a lunchtime drop-in or a school breakfast or homework club – there should be something for everyone.

In the immediate future there will be many opportunities, especially in the construction industry. As we broke ground for Phase 1, we wanted Battersea to be at the centre of the Nine Elms project, with our experts training local people to do local jobs so they could lead local lives.

This is going to involve building partnerships within the area with both private and public sector organisations, working closely with them to identify their requirements and what we can all contribute. Our education team will work on our behalf to make sure we turn a diverse mix of ideas into a vision for local learning that we can quickly and easily put in to action.

On the practical side, we will also be offering a learning resource base, so that any instructor in the area can get access to photocopying and a web design service to get their new learning programme publicised. Over time, we'll build a team of community-based instructors who open new doors for people and make learning fun again.

### **FACT:**

According to the National Institute of Adult Continuing Education, 38% of adults have participated in learning in the last three years. The same survey revealed that adults with internet access are more likely to have taken part in learning in that time than those without internet access.

*Opportunities to learn are just around the corner.*



## 43. Graduate showcase

Learning often takes place behind closed doors. Its effects are largely invisible – a shift of perception, a new approach, a change of priorities. Learning gives us a great inner sense of achievement and it's good to celebrate this and show off the outputs.

At Battersea we want to host and incubate new kinds of learning, allowing talent to prosper and people to reach their full potential, particularly in cultural and creative sectors. We aim to be London's leading creative community, especially in our ability to nurture and support creative thinking from the ground up.

Right now job openings for recent graduates in the creative sector are pretty competitive and they are going to need more in the way of support, such as transitional experiences after college and other

opportunities to be able to launch their careers, their collections, their inventions.

By developing a range of design shows, creative residencies and start-up units, Battersea will be able to grow a community that provides mutual support and a love of learning, putting culture at the heart of everything we do. This way cultural knowledge will become a key asset of our workforce.

Part and parcel of this showcasing will be the spaces dedicated to the arts and cultural activities at Battersea: theatres, cinemas, galleries and music venues.

This will be a community that builds on its own successes and genuinely believes in promoting each other's work to the outside world.

*Create links to*



**FACT:**

The HSBC 'Future of Business' Report surveyed 500 entrepreneurs and business decision makers and asked what they thought business in Britain should be about: world class creative industries were the most important priority, at 56.5%, followed by 46.2% emphasizing the need for a top class education and training system.



*nurture tomorrow's talent.*

## 44. Leading edge

It's tough being at the top of your game. All the hours you have to put in, all that networking and face time. All those project briefings, team building exercises and technical updates. Executive education aimed at this group can often be wide of the mark because it's simply not interesting and stimulating enough. Or, in the current climate, too expensive in both time and money.

Where in London can you go that keeps travel time to a minimum and gives you the focus that a quality executive retreat requires? Where do you find surroundings that are conducive to good conferencing and business development, with clients and collaborators right on the doorstep? In just a few short years, we aim to turn Battersea Power Station into the obvious choice with a state of the art conference centre and facilities that encourage, rather than stifle, blue-sky thinking.

### **FACT:**

According to the International Congress and Convention Association, in just four years, London has risen in global popularity from being the 19th to the 17th most popular city in the world for international conventions and conferences.

There'll be the right kind of space to host all kinds of courses, workshops, conferences and debates. Where senior management personnel are given the flexibility to respond to different corporate educational needs in terms of support, space and technology. And when the event is over, there will be plenty to do to help you and your team unwind with your new compatriots, either in your hotel or within The Power Station itself.

We want to become known as the specialist organisation for offering executive learning and facilitation, because we have surpassed the benefits offered by our competitors when it comes to achieving valuable face-to-face time. These opportunities are few and far between. They shouldn't go to waste.

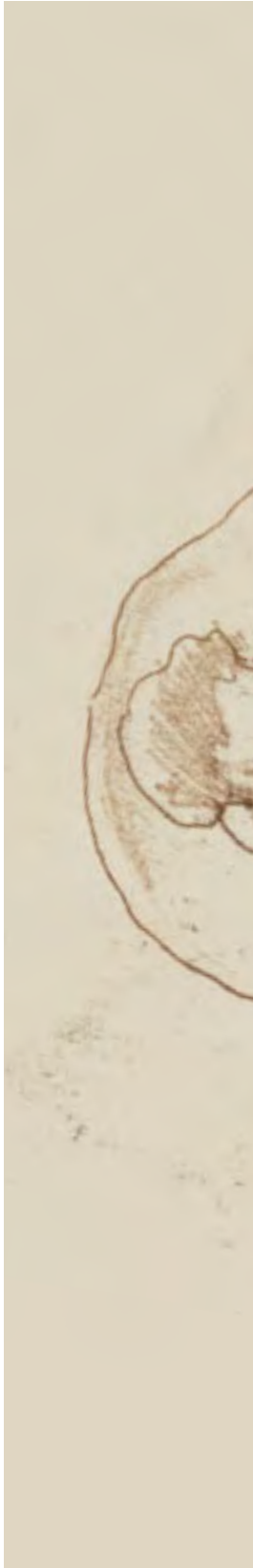



*Meeting the right people,*



*in the right place.*

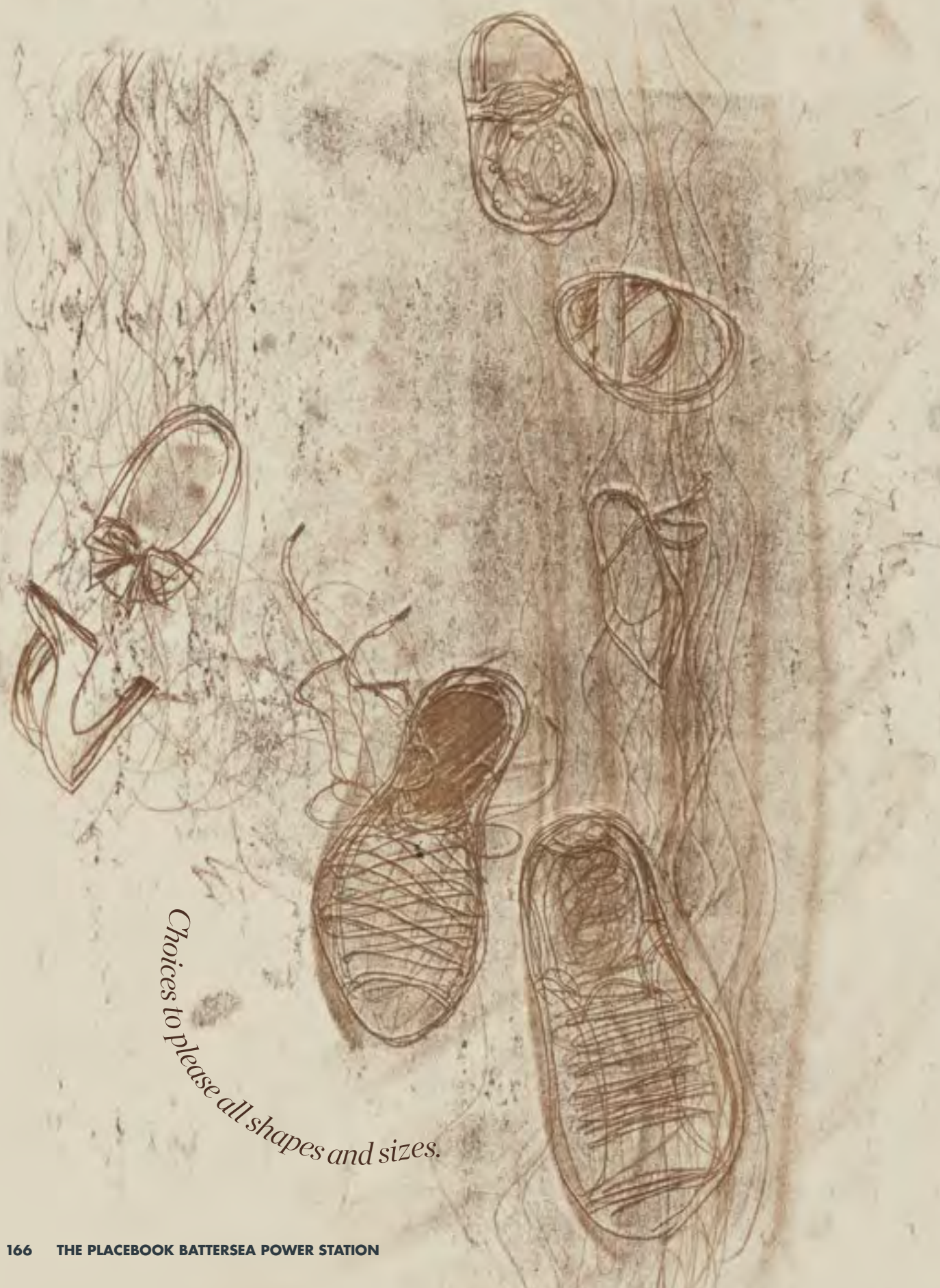

*Choices to please all shapes and sizes.*

## 45. What's your thing?

There won't be olden days costumes or any gruesome stories to tell (we hope), but a guided tour around Battersea Power Station will make for a powerful experience in anyone's book. It will almost feel like time travel!

Back to its dirty coal-fired existence in the 1930s, although it was quite advanced with its gas-washing technology, then fast forward to the latest in clean energy design with the Combined Heat and Power plant that runs on renewable energy. The tours will give insights into how our pre-war forebearers used the huge analogue dials to keep track of the gigawatts being generated the old way and then bring us right up to date with digital technology monitoring how much renewable energy The Power Station is now giving back to the National Grid.

And if the energy story doesn't do it for you, you'll be able to engage with a whole range of other tours and experiences at Battersea. Like gourmet tastings with a leading chef or food writer who will take people round to sample the fabulous epicurean food offer at Battersea Power Station and conclude with a cooking masterclass.

Or regular talks with one of our resident artists or guest curators, followed by a guided tour through our gallery spaces that ends with high tea in the Control Room of The Power Station – one of the most remarkable rooms in London.

For the fashion-conscious, there'll be days when our on-site fashion houses, whose latest creations will grace the next catwalk shows of London Fashion Week, open their doors. Here you'll get a sneak preview and a chance to talk to the designers themselves.

Whatever floats your boat, Battersea Power Station will be a place where you get a more tailored and personalised experience.

### **FACT:**

The Museums, Libraries and Archives Council found that nearly 75% of local residents believe that investing in the historic environment makes local areas more attractive; 61% say it makes an area a better place to live.

## 46. Library 2.0

Public libraries are not what they used to be – somewhere you went to borrow a book. Now they're a kind of one-stop shop for all kinds of information sources, but more importantly, they're a key part of any community and help to build its identity.

Now there's the threat of closure looming over many of them. We want to rescue, rehabilitate and update the concept. We want to take the best of what a good local library has to offer so it's somewhere everyone always wants to spend some quiet time, whether it's to browse in their lunch hour, revise in their Easter holidays or socialise at the weekend.

We love Brighton's Jubilee Library, which embodies the traditional functions of a library but also animates one side of the city's new Jubilee Square, with a quirky bookshop ready to welcome people into the library any day of the week. Similarly, our Discovery Centre and library will work hand-in-hand to enrich and support the community in and around Battersea Power Station.

To be a real neighbourhood, Battersea needs places where people can gather and really feel at home and then give something back to their community. Some people call them 'third places'. Our library concept is open-ended like a third place, somewhere that residents can plan and shape over time, generating a wealth of shared memories and experiences. Sure we'll have books, newspapers and computers, but if you're after a bookable meeting space, a rehearsal room, a recording studio, or even a game den, look no further – but make sure you keep the noise down!

But it's not just confined to one place – the idea of Library 2.0 is that it pops up as pods and kiosks, providing little moments of micro learning all over the site. Sometimes they'll be where you least expect, but mostly where it just feels right for there to be a quiet corner with an armchair and the opportunity to peruse something for ten minutes. The reading matter might well be digital, but the armchair will be real and comfy.

### **FACT:**

According to The School of Life, a new book is published every 30 seconds and you would need 163 lifetimes to get through all the titles offered on Amazon.

*Somewhere local  
I know I can rely on.*



# joining <sup>up</sup> the dots

Cutting-edge Placemaking is now also about achieving a seamless experience of the physical, the social and the virtual. To succeed, Battersea must operate simultaneously as an exciting real and digital environment with a genuine sense of community.

*Illustrations: Gabriella Voyias*





Over the past 20 years, due to the evolving and growing role of technology in society, our understanding of making contact and 'being connected' has been completely transformed. A connection to a place is no longer simply about local, physical and geographical ties. Often people are connecting to the place more as a collection of ideas and associations, fostered remotely and developed out of shared and common interests between people.

As a result, most people would not recognise their life today without email or the internet. A recent survey by the Joseph Rowntree Foundation even found that having no personal access to the internet is now considered an indicator of poverty. The rate of change in these personal circumstances is enormous – smartphone apps that now boast millions of users simply did not exist even five years ago.

As a consequence, perceptions of the physical world are undergoing some subtle but fundamental shifts in terms of how people navigate space, encounter place and, at the most basic level, go about their daily lives. As informational and navigational technologies continue to evolve, the challenge is to use them ever more creatively to support the connections people form with each other and, by implication, enable great places to continue to thrive and be differentiated from each other.



Placemaking needs to help generate a greater sense of ‘connexity’ – that is to say the inter-relationships between places, people, their machines and the global communications network.

### **NAVIGATING SPACE**

To get from A to B, maps and atlases were once the primary resource, however recent figures have shown we simply aren't relying on them like we once did. Leading publisher HarperCollins reported the sales of maps and atlases declined from £13.5 million in 2006 to £9.7 million in 2010. In the past six years, sales of road atlases in Britain have fallen by 30% and street atlases such as the A-Z, by 44%. Fewer people are using these kinds of navigational aides than ever before and are instead turning to sat-navs and mobile apps which not only provide directions but also offer at one's fingertips a more dynamic and informative landscape.

Of course, to work well, these devices depend on there being a fully integrated transport infrastructure in place. At Battersea Power Station, London's already sophisticated infrastructure is being augmented with new tube, bus and riverboat connections to other parts of the city; transforming what was essentially an urban backwater into a central component of the capital's social and cultural landscape. But these big moves aren't in themselves enough.

At a more fine grain level, it is also important to make clever use of landmarks, features and signage to help people locate and navigate to their final destination, as demonstrated by the Legible London project which has reduced the number of pedestrians getting lost on a journey by 65%, simply through the introduction of effective and well-placed signage.

But it's more than improving our ability to locate and arrive at a destination in a physical sense. Smartphones as GPS-enabled devices now offer location service apps that help people orientate themselves in a place on new levels, encounter friends and other users and share their whereabouts and experiences in real time, such that navigating physical space even includes letting the wider world know what you think of it. Battersea needs to take a strong lead here, to become one of the most sophisticated places to be in terms of location services and integrated place-based media. Just being able to use these services to hail a taxi or find the best burger nearby is not enough.





## RECONNECTING PEOPLE TO PLACE

The digital world is not only changing the way we find places but also how we relate to them before we even arrive and once there, how we participate and socialise. In the UK, laptop and desktop internet users spend at least 35 hours each month browsing the web, according to Ofcom; over 30 million people are regularly on Facebook; over 10 million people are registered LinkedIn users; and globally there are 225 million users on Twitter and counting. For a place to really succeed, it needs to dream up new ways to engage with these multiple online communities and to offer 'visitors' something more than just an informative online portal, if it is to make them want to come to the physical place.

Whilst the online world is often portrayed as a trivial distraction in people's everyday lives, it is in many ways helping people to orientate themselves within and establish deeper connections to the physical world. A web-based concept such as Groupon, which now operates in nearly 50 countries around the world, offers location-based deals for specific places. The consumer can enjoy a localised discount, whilst participating businesses access new markets and acquire new customers.

Rather than rendering face-to-face social encounters irrelevant, the virtual world merely changes our relationship to them. Our need for neighbourliness has changed, but we still crave friendly day to day interactions, yet are often forced to rely on digital communication to stay in contact because of our busy schedules.

Moreover, people are tending to put down roots in a particular place later in life, usually when they start a family, leaving London's young professional flat dwellers often with a huge but undisclosed sense of alienation.

A recent study for HSBC found that the UK is running the risk of becoming a nation of 'street strangers' rather than good neighbours. This study found that people in rented accommodation rarely become acquainted with their neighbours, compared to homeowners. It follows that many of the dense new residential developments that have been built in central urban locations over the past 20 years are tending to push people apart, despite living in close proximity to each other.

That's why we've focused a lot of attention on how the residential communities at Battersea can be configured to allow for more meaningful voluntary social networks to develop, so that people who live and work there can lead more fulfilling lives and genuinely take account of the ways in which technology is changing people's behaviours. For us, the physical environment is all about creating the right circumstances for a good social environment to flourish, whether this is maintained on or offline.

# Strategic thinking: Connecting

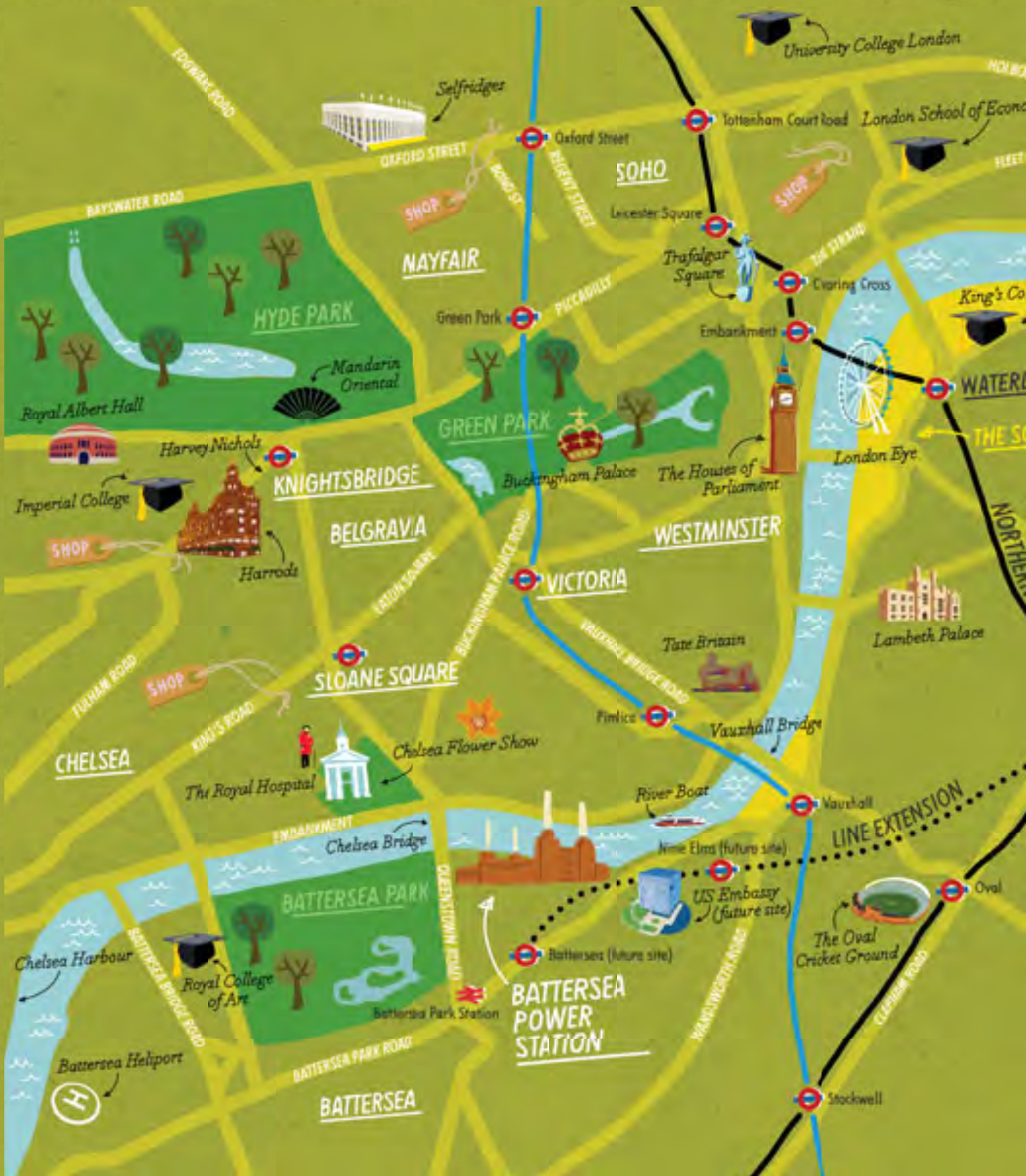



### NEW CONNECTIONS

The introduction of the Northern Line Extension increases Nine Elms and Battersea Power Station's connectivity both physically and perceptually for Londoners.

### BELONGING

One aspect that new urban developments often overlook is the connection to the surrounding, existing urban context and the result is often the creation of an isolated socio-economic enclave, whether or not it is gated. Right from the outset we have made local people and the local context in and around Nine Elms a priority in developing our thinking for Battersea Power Station. Locals who already call the Nine Elms area home need to feel a continued and strengthened sense of belonging to the local area once Battersea Power Station is up and running again.

The most recent UK Citizenship Survey showed that over three quarters (77%) of people strongly felt they belong to their neighbourhood. Anything new must enhance this sense of belonging. The physical offer at Battersea – its riverfront park, shops, cafés and public spaces – must feel like it belongs to everyone across Nine Elms and Wandsworth, not just to the 16,000 new homes expected in the local area.

In researching the theme of connecting, we've come to an understanding that walls and distance are no longer perceived as boundaries but just demarcations within a wider continuum. Whilst as developers our core business is often perceived to be building walls and defining boundaries and curtilages, the real project is to create a place and an identity that overcomes the physical limits and makes full use of the virtual scope to achieve maximum connectivity between people on every level. Through an intelligent and ingenious use of place-based and social technology, the connections we facilitate will last for many years to come.

**FACT:**

There are 270 stations served by the London Underground network, carrying over 1 billion passengers each year. Currently there are only 29 stations south of the river.



## 47. Getting there

You know how there are lots more Underground stops north of the river than south, right? And that it's quicker to walk from Leicester Square to Covent Garden than catch the tube. And that some parts of town are relatively isolated within the public transport system and hard to get to, even if they're not that far away?

London's like that. In 1935, Crouch End and Stroud Green were scheduled to be new stops on the Northern Line, but with the outbreak of World War II plans were put on hold. After the war, passenger numbers didn't warrant the new electrified stations and by 1954 the plan was ditched. Yet it's funny how both these places have a really distinctive character despite the fact that you have to catch the bus there. Or walk. Or cycle.

Now Battersea is going to get a stop on the Northern Line, making it just six stops away from the City and Soho. The arrival of the tube will be a big moment for The Power Station and Nine Elms, but by then, we'll have already proven its potential as a non-car orientated visitor destination, with enviably green statistics showing that the majority of people arrive by public transport, bike or on foot.

Like the Crouch Ends and Stroud Greens before us, we're confident people will beat a path to our door, whether by River Bus, on a 'Boris Bike', on a red double decker or an executive Battersea bus.

*Getting there – so many ways, it's difficult to choose.*





Battersea is already a new hub on the London Cycle Network, a pit-stop where you can get your bike checked over while you meet up and have a coffee with other cyclists. Plus, if you want to be really flash, Battersea Power Station is only a stone's throw from London's heliport.

People tend to think Battersea Power Station is much further from central London than it actually is. But it's just a perception thing.

We've tested it out: get on a bike and you're 10 minutes away from Big Ben. Start walking and you're 15 minutes from Sloane Square. Catch a bus and you can be in Knightsbridge in 25 minutes. Add the River Bus service into that mix and you'll be able to get from Battersea to your desk in Canary Wharf in just over 30 minutes.

But if you had any sense, you'd have an office in The Power Station itself and stroll there in two.

## 48. Behind the scenes

There's something very satisfying when you come across a place that's really well organised, well run and well maintained. Everything, as they say, is 'ship-shape and Bristol fashion'. But let's face it, that doesn't usually happen by accident – to keep things ship-shape takes a very good skipper.

Battersea Power Station is pretty similar in size to a large cruise ship, with a fairly similar mix of uses on board – residential accommodation, a large volume of working space, as well as shopping, eating and entertainment. Let's forget about the underground parking for the moment – this skipper has to preside over a complex organisation, with many different operators each playing their part in keeping the thing going. From our roof gardens at deck level down to the engine room beneath, someone has got to keep track of daily deliveries, waste disposal, VIP arrivals, as well as ensuring that during construction the parts open to the public are kept safe and clear at all times.

Clever software and a few eagle eyes should take care of a lot, but computers aren't good at getting the tone right – making sure that the on-site security presence is polite, friendly and discreet. Liaising with the local authority and the Mayor's Office over logistics for big events, dealing with customer complaints and incidents. That all takes diplomacy and good judgement.

Behind the scenes will be a team of place managers working closely with the place director, to realise the experiential vision on the ground, 24/7, 365 days of the year.

OK, now bring the parking back into the mix – because the underground car park will be many people's first impression when they come on board and this needs to communicate all the same values as everywhere else.

Ironically, to keep to our number one manifesto point, 'no default', requires the place manager to set a whole load of new defaults and then stick to them, day in day out.

That way we can ensure everything is far from plain, but definitely plain sailing.

**FACT:**

Upon completion, Battersea Power Station will be home to 7,830 residents. At capacity, the world's largest cruise ship is home to a comparable number with 8,000 people including passengers and crew on board.



*Behind the scenes – that is where the magic happens.*



*I only get lost when I want to.*



## 49. Signpost



Being a bunch of villages that have joined together, London's not the easiest city in the world to navigate. Over the years, there have been many different signage systems installed to help visitors and locals get around, but more often than not, these signs seem to offer conflicting information and just confuse all of us even more.

We've been told the worst part of getting to a particular destination is the last hundred metres or so, even when you're armed with an address and a map of some sort. It's partly the result of poor street and building naming and numbering systems and partly because the designers or developers didn't think things through at street level and take into account how different people like to navigate and move around in our urban world.

The 'strollers' among us move slowly, take their time, notice their surroundings and are not too focused on reaching a particular destination. The 'striders' are more purposeful – they want to get somewhere as directly and quickly as possible, with the fewest interruptions or diversions.

We need to make sure there are signposts for everyone, no matter what their speed or sense of purpose is and for signage to offer more than just an extra sense of direction. The best kind of signage not only lets you know your whereabouts, it also orientates you to the nature of the place itself. It connects you to both past and present and brings the place to life in new ways, by opening up perceptions about how it connects to other times as well as other spaces in the city.

Signs also can help children and their parents feel safe, without being inhibited – the mood they convey is important, giving permission to chill out and play. With all this in mind, we want wayfinding in and around Battersea Power Station to be friendly, human and informative. So as well as putting posts in the ground with carefully designed pointers, there will also be a team of multi-lingual Battersea 'rangers' who roam the site and help people get where they want to go.

### **FACT:**

A TFL study found that the iconic and simple London Underground map is the most popular wayfinding tool for people planning to navigate round London, whether they are travelling above or below ground.



## 50. Is that for me?

The hoarding around Battersea Power Station is just a temporary thing. We have no plans to turn it into one of those gated developments – we’ve seen too many on our travels to know it’s not what this part of London wants or needs.

In fact, given how cut off the site is right now, our aim is to do the exact opposite: open it up wherever and whenever we can, to get people walking through at all times of the day, connecting it to Battersea Park, Queenstown Road, Vauxhall, Battersea High Street, New Covent Garden Market and eventually the new quarter around the US Embassy.

There’s a fascinating working wharf next door to us, which in time we hope to also have access through, so that our new riverside park makes a continuous Thames walk going downstream to Vauxhall and beyond, taking you all the way to Rotherhithe if you like.

More importantly, closer to home, we plan to make Battersea Power Station feel like it belongs where it is. What we mean is, belongs to the people who live all around it and is a big part of their lives.

It’ll be somewhere locals hold a reading club or wander through on a summer’s evening to catch the sunset. It’ll be where their GP’s surgery is and where they do a pottery evening class. They’ll all carry a membership card that gives them discount on loads of things at Battersea, because they’re locals and they are part of what’s going on there – they might even be a supplier, baking cakes for our independent café or printing our stationery, or serve as part of Battersea’s service team.

So instead of making it feel like somewhere exclusive and out of people’s league, we are trying our best to ensure Battersea comes across as an easygoing place that appeals to everyone, with plenty of appeal for everyone, week in week out, year after year.

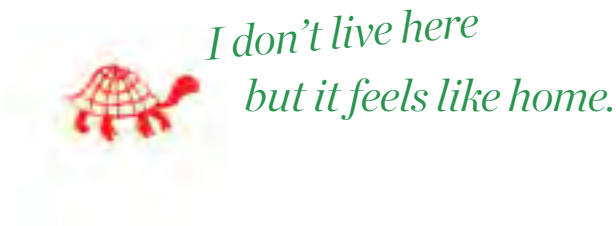

## 51. Have your say

We've all been to one of those community meetings where you wonder why you bothered. Everything's been decided beforehand and no-one there seems to really want to listen to what you have to say. They just need to be able to say they asked you.

That's not the way at Battersea. Not only will residents, workers, shoppers and visitors be able to register their suggestions and ideas, they will also be actively encouraged to get involved and have real influence. Because if you don't offer that these days, we all know anyone whose voice is not heard has a ready way of broadcasting their feelings via the social media.

On a mundane level, as Battersea gets going, there are bound to be issues that people who use the place every day can help us resolve, whether it's about the landscaping, the construction traffic, the buses, or the recycling arrangements.





*Get involved, make a difference.*

Talking to the people who use the place will help us iron things out and get them just right. On a more inspirational level, our on-site population might know about shows, bands or acts they'd like to see perform in our theatre, books and magazines they'd like in the Battersea library, or shop outlets they would welcome in the retail spaces.

Having your say is all part of making Battersea the best place it can possibly be for everyone who spends time here. Having your say may even lead to getting involved in the festival planning, or volunteering to help in the crèche at the weekend, or becoming a Battersea 'play ranger'.

Most importantly, it's seeing something happen as a result of your input that really builds a community with a sense of pride in its place.

**FACT:**

In the most recent Citizenship Survey, 39% of people in England said that they felt able to influence decisions affecting their local area. 31% of London residents said that they felt able to influence decisions affecting the capital.

## 52. Digital Battersea



These days our first encounter with most places is digital – you look at a map on your phone or tablet before you set off, consult a museum’s website for its opening hours and to see what’s on, or choose your seats from an online ticket agency and while you’re at it, check out the sightlines to the stage.

We do it so often we don’t even think about it, but those seamless connections between the virtual and the real place all go together to form our overall impression. Now it’s no longer even a case of doing all this beforehand – with place-specific apps installed on our mobile phones, we can be simultaneously in the real place and the virtual place. We expect them to join up and be easy to use.

So it goes without saying, now that construction is underway, we are already developing our Battersea app – one we hope will break new ground in other senses too. As a place, Battersea will be carefully curated and the app needs to form part of this, helping the user to add new dimensions to their cultural and social life by suggesting new shops to visit, exhibitions to attend and restaurants to try.

We’re also thinking about how an app can make our commercial and residential tenants’ lives just a bit easier. Need a meeting room? Book it on the app. Need dinner? Order it on the app. Services should just be a swipe or two away.

**FACT:**

In the first weekend Apple's App Store was open, in July 2008, over 10 million apps were downloaded.

*Nowadays,  
I can be anywhere,  
anytime.*

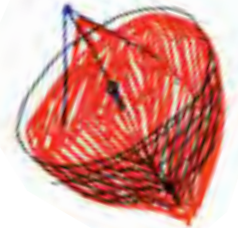

How about the Battersea website? That's going to connect with a wide range of different user groups, some wanting to learn more about Battersea before they visit – what's on or learn about the site's history, others wanting to visit The Power Station from halfway around the world. More importantly, the website will be the place to go to learn about new design talent and creative ideas, because we'll make sure they have made Battersea Power Station their home.

In future, we'd expect Battersea not only to feature on any new digital platform, but to lead the way in terms of its development of innovative content and functionality. To this end, we plan to have some whizz-kid ICT developers as part of our service team to roll stuff out on a regular basis, win awards for us and generally keep the digerati on the edge of their seats. Because we can be nerdy too.

## 53. Going global

Is it OK for a bit of boosterism now?

Here goes: Battersea is part of the largest redevelopment taking place in Europe right now. There won't be many other places built in the next 20 years in a major world capital that will have the same scale or level of ambition.

But it's not the first. There were others before us that broke the mould, some decades ago, and people still go there to see the end result, places that we still think are up there.

Take Malmö (Sweden) or Freiburg (Germany), leading the way as sustainable cities for the future. Then there's Celebration and Seaside, those Florida new towns built on traditional principles of neighbourhood development. And what about the cities of tomorrow? Masdar (UAE), designed to be one of the most sustainable cities in the world and Songdo (South Korea), a city built from scratch where all its information systems are linked, are two of the urban places currently being talked about in terms of smart cities of the future.

### **FACT:**

Since sustainability leader Malmö opened the first phase of the city's Western Harbour development, Bo01, the city's total income generated by tourism has grown substantially – increasing by 70% in ten years. In 2009, the city was acknowledged for its significant achievements and was awarded the UN Scroll of Honour for its innovative and holistic approach to becoming a sustainable city.

But very few places capture our imagination in the long term unless their contribution to Placemaking is properly communicated and widely disseminated. That's part of our job. Sure, the journalists will come when it's newly opened, but if we want them to continue to take an interest in what we're doing, if we want Battersea to be a headline case study at major international conferences for years to come, we'll have to start talking now!

Armed with press packs and learning materials, we'll be ready for anyone who wants to know more about our Placemaking efforts at Battersea Power Station, from influential mayors of global cities to the hotly-followed bloggers and tweeters with a passion for urbanism. While Battersea Power Station isn't physically as big as a city, our ambitions to create a place that everyone wants to see won't be topped by anywhere in the world.





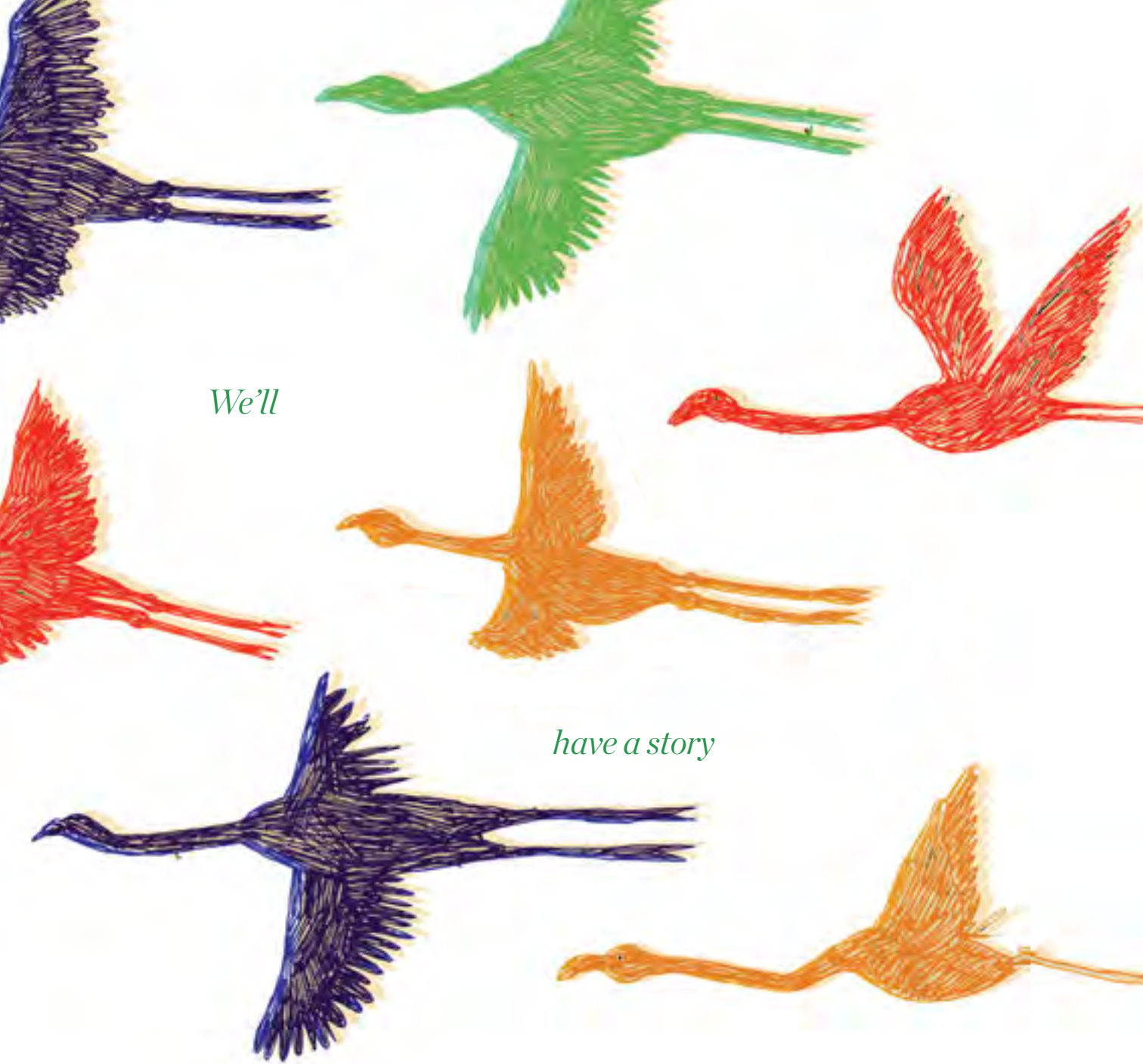

*We'll*

*have a story*

*to share.*

## BRANDING

the marqne  
OF a GREAT PLACE

Place branding expert Simon Anholt uses what he calls the 7-year-old test when advising clients – how would a 7-year-old describe the place and would it make you want to go there?

*Illustrations: Bradley Bell*

Place branding is a fairly new concept, although in practice it has been going on for centuries. In recent years, the conscious manipulation and consumption of place has issued a wake-up call to the branding industry. It's no longer about creating a logo or tag line, but rather about making a commitment to a broad and inclusive strategy that focuses on what distinguishes one place from another and also takes a community-wide approach to communicating and creating a unique destination experience.

Place branding is not advertising-based; it's about delivering an exceptional, memorable and emotionally resonant experience. And one that will stick with those who are going to come and live or base themselves there.

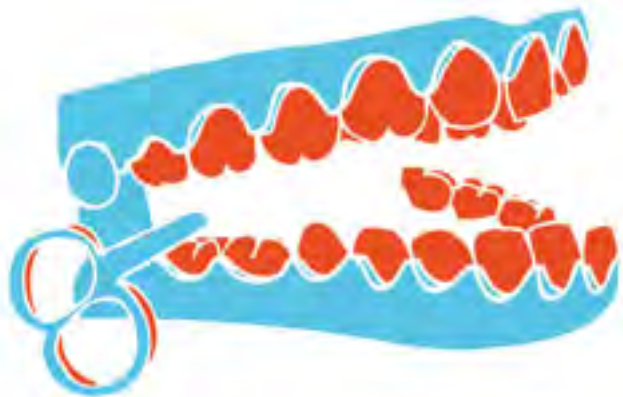

On the face of it, place brands bring together the spheres of leisure, tourism, audience development, event management, property marketing and corporate identity.

But successful place brands don't conform to a magic formula. They are regarded as destinations to reckon with, by offering something special that you can't get anywhere else. In the UK, place brands that have worked and continue to push the envelope include the Eden Project and Tate Galleries. While on a global scale, the Guggenheim and Disneyland have raised the bar in terms of merchandising and audience development.

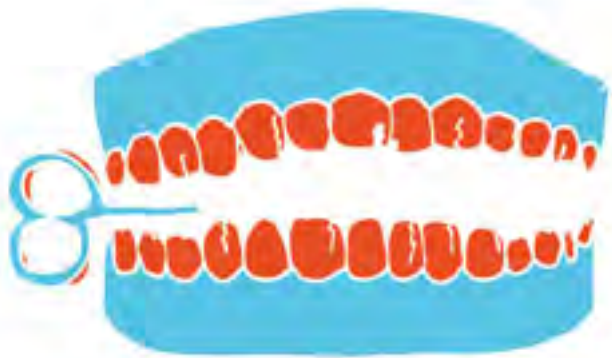

## **BRAND PURPOSE**

Where should the focus of Battersea Power Station as a place brand lie and what should it take inspiration from?

Many parts of cities, including London, have been branded long after they have been in existence, in an effort to bring a different focus and renewed interest and to sustain this through re-naming, re-shaping and re-programming.

In London, Seven Dials, Newburgh Quarter and Bankside have all been through this active rebranding process, while other areas have been effectively rebranded by dint of latent gentrification or regeneration: Hoxton Square, Kings Place, Lamb's Conduit Street. It is important to recognise that with the latter kind of place, transformation tends to produce more enduring places with greater cultural cachet.

There is an opportunity at Battersea Power Station to take an existing monument, which is well known and highly recognisable, and give it a different meaning and association primarily through authentic Placemaking activities. The challenge with place branding is to integrate the overall experience of the place itself on many levels, dealing with space and time, look and feel, day in day out. Ultimately a place brand will be judged by how consistently it communicates and then lives up to expectations and conversely how fresh and unexpected (in a good way) the experience on offer is compared to last time.

## **CORE IDEA AND BRAND PERSONALITY**

The late Wally Olins emphasised the importance of the link between external and internal consistency with regard to branding: in his view, "outward consistency will only be achieved and for that matter is only appropriate, if it is the manifestation of an inward consistency – a consistency of purpose". This purpose he argued derives from having a clear vision or core idea.

The core idea behind Battersea Power Station is about generating and maintaining a place experience that is consistent with the ten points enshrined in the Manifesto, beginning with 'NO DEFAULT' and ending with 'MASSIVE ICON, INTIMATE PLACE'. These ten points encompass the brand personality, as well as how it is tangible as a product, as an environment, through behaviour and communications. None of these facets of place is any more or any less important than the other three. The face-to-face encounter with Battersea Power Station must live up to its presence online and in the media and conversely we must provide the inspiration for the way it appears elsewhere, to make sure this is every bit as exciting as actually being there.

As important as the totality of a place experience, people are also looking for more alignment between their lifestyle and the places they visit. A recent survey revealed that 71% of people say they make a point of buying from companies whose brand values are similar to their own. Among those at the top of the CoolBrands ratings are Apple, Aston Martin, Nike, Alexander McQueen and Dom Pérignon. What all of them have in common is that they offer more than the simple ownership of a phone, a car, a pair of trainers, a dress or bottle of bubbly.

Joe Pine and Jim Gilmore call this phenomenon *The Experience Economy*, the latest stage in global society that follows on from the historical trajectory of agrarian, industrial, service and knowledge economies. In the experience economy, what is on offer is no longer just the product. It is more about the experience that comes with the product and the transformations this elicits in those who partake in the experience. It's a different ball game and one that works best when the nature of the experience is seen to be authentic, because this has the greatest potential to affect emotions and hence build rapport. Given the amount of manufactured, synthetic and homogenous choices and experiences on offer in today's society, finding places and things that seem real and genuine can help to set them apart from the rest.

## **BRAND DEVELOPMENT**

At the heart of Battersea there is a building, which needs to be restored and made over without killing its soul. It will be important to bring in the right mix of businesses, retailers, cultural institutions and people to create the experiences consumers seek today. Their profile is taken to be indicative of the profile of the destination as a whole – which, as always, needs to be greater than the sum of the parts. With a typical mixed-use development, the tenant profile reveals a lot about what sort of place it is. Every development has to balance opportunities to let space and sell units to those who will offer to pay the most and those who will give the place more atmosphere and kudos. It is important in developing a place brand, therefore, to get the right mix from the start and keep fine-tuning it.

As far as Simon Anholt is concerned, developing a place brand consists of three key components: strategy, substance and symbolic actions, which need to all work together as one. The strategy defines the game plan and determines who you are; the game plan shapes the substance and identifies the right means and materials to make the plan consistent and convincing and able to come to life; the symbolic actions are about proactively and visibly enacting the game plan.

Effective brand development will give rise to a positive brand image, something which lies beyond the control of its owner or originator. This is because brand image is about reputation and is based on perceptions compiled from a person's total encounter with a brand, whether this is physical or virtual, individual or collective, conscious or accidental. More than ever before, in the age of social networking, this includes word of mouth. With armies of brand loyalists forming rapidly on Facebook, YouTube and Twitter, just a few negative comments or reviews can adversely affect a place brand. Only if it's adopted the right strategy from the outset can a brand recover from this with ease.

# Strategic thinking: Branding

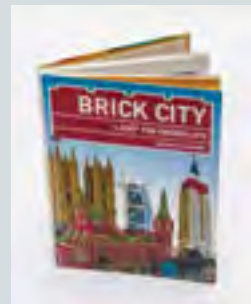
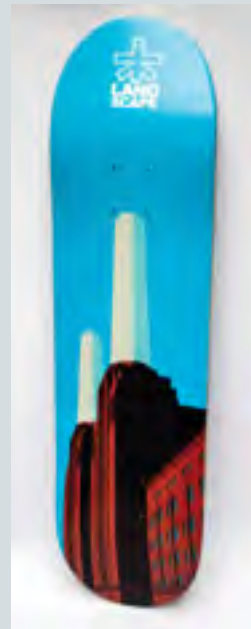
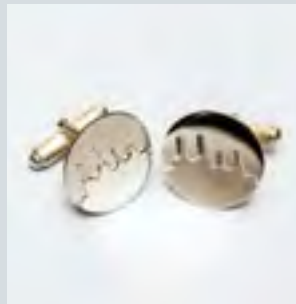

For list of items and suppliers see page 223

## BRAND POSITIONING

This is how a brand is managed dynamically so that it improves as time goes on. Battersea Power Station might be going from a standing start as a new place, but it will be able to draw on the fact that it has already staged a great many high profile events as well as been used for film and fashion shoots regularly over the past years. That, coupled with its cultural associations linking it to brands and bands ranging from Converse to Pink Floyd, will give it a head start. There have been other place brands that have come from nowhere and been listed in the CoolBrands rankings within five years and it is important to aim for nothing less.

To do this means acknowledging that the image of Battersea Power Station as a place will necessarily change over time, from a funky and edgy creative quarter on the river to a fully fledged neighbourhood with a tube station and luxury hotel to boot. Each transition requires a subtle act of re-positioning a place brand.

In the early stages, this is shaped by the design of the place and, once up and running, it will be determined largely by the management of the content and images presented. Over time, people will be living the brand, becoming willing advocates and acolytes of the place. Their enthusiasm will promote it more effectively than any marketing campaign and will embed them more deeply into the fabric of the place. Place branding is about going beyond brand loyalty – in the final analysis it is about making people vote with their feet: by coming to live, work, learn and play at Battersea they will form a sense of shared pride that for a place brand is the most powerful outcome of all.

Only then will the proverbial 7-year-old go home after a school trip and say that at Battersea Power Station they had the best day ever.

## BATTERSEA EXISTING MERCHANDISE

Battersea Power Station is already a powerful place brand. A simple Google image search reveals a myriad of products that utilise the image of the building – in effect, The Power Station store is already open for business.





I quit AGES ago



54

total RESPECT

We've stopped people in the street and asked whether they recognised Battersea Power Station and what they think of it.

Most people know it as a crumbling roofless industrial structure. But they're not indifferent to it. In fact, a lot of them were quite cross it's been in that state for so long.

It's pretty clear that our first challenge is to convince people that something good is going to happen. It's all about TLC for a part of London's heritage that almost got away. A comprehensive rescue mission which will transform what people know as a visual icon seen from afar into a place, a physical experience that they can enjoy up close and personal.

So a key aspect of Battersea Power Station's emerging brand is for people to associate it with a careful and considered process of restoring and cherishing something unique.

In other words, total respect.

For this to work, The Power Station itself needs to serve as the centrepiece around which values are built, both physically and emotionally. It will be a renaissance fuelled by the building.

**FACT:**

Research conducted by English Heritage found that £1 of investment in historic environments generates £1.6 of additional economic activity over a ten year period. In the same study, 90% of respondents agreed that historic environment projects had raised their pride in the local area and 93% that it had increased their sense of place.

**FACT:**

A global study of 7,000 young people (Generation Y, 13-29 year olds) found that authenticity ranked highest along with commune (the need for connections, relationships and community) and justice, as the top three motivations for young people today.



DON'T forget YOUR  
ROOTS

55

## LISTEN TO THE PLACE

Wandering around the empty and brooding Power Station you don't need to think – you can *feel* its authenticity – in the exposed structure, the heroic scale of the brickwork and the unexpected delights of the Art Deco Control Room.

But if defining authenticity is difficult enough, creating or maintaining it is even harder. Turning Battersea Power Station from a derelict industrial landmark to one of the world's most iconic places is not a task for the fainthearted. Nor is it for the insensitive, because to be truly successful the next stage in the life of The Power Station needs to be a logical evolution. We need to listen to the place and let it guide us.

Of course the masterplan already does this, with The Circle cradling the existing building, The Power Station Park addressing the river and The Prospect providing new connections through to Nine Elms. It's not a copy of somewhere else, it's a unique response to a unique set of physical circumstances.

But listening to the place, making somewhere locally distinctive, goes beyond urban design and an architectural aesthetic that works with the existing building. It's also about listening to people. It's about being a detective and finding out what is going on in the immediate area. It's about thinking how The Power Station can tap into local energy, nurture fledgling businesses, harness creative talent and make itself the centre of everything that already exists. It's about giving local firms, institutions and partnerships what they need: space to grow and a chance to make their dreams part of the Battersea adventure.

Starting from scratch is a daunting task. Listening to the place is a strategy for building on existing momentum and, above all, for keeping it real.

## 56 INSTANT ACCESS

Battersea Power Station was last used in 1983. Since then there's been lots of stories, several owners, a few schemes in the newspapers and seemingly zero progress with any of them. How are we going to change the jaundiced views people have of this legacy of inertia and inaction?

Becoming the fastest selling residential project in London ever has probably been a good start. Also, we hope that having both the Prime Ministers of Malaysia and the United Kingdom start construction by breaking ground on Phase 1 would inspire people to think about the project in a new way.

But we're not resting on our laurels, we think it's important to just let people onto the site. Let them come and have a look around. Get up close to this immense structure that's somehow still standing and marvel at what it's about to become. You don't need much in the way of theatre or a full-on sound and light show to understand the enormity of either the building as it is, or the task that faces us.

You just need to be allowed near its big brick facades and feel its presence looming over you.

That's why the very first thing we've built is a Pop-Up Park – right in front of The Power Station and alongside the Thames. Who was it that said 'build it and they will come'? Well we did and in the past five years nearly half a million people have – which just proves our point: people are really nosy and fascinated about what is happening.

Millions of people have seen images of The Power Station's incredible interiors in films, magazines and on TV, whether they're aware of it or not. Now it's time to build on the success of these early theatrical events and open the gates to everyone. So for the first time, The Power Station was part of Open-City London – and we welcomed a record crowd of 40,000 people over the weekend.

What's important is that whatever we do to build our brand needs to be based on real experiences, not just some marketing gimmicks.

In other words, more show, less tell.

# CHIMNEY Sweep RELAY





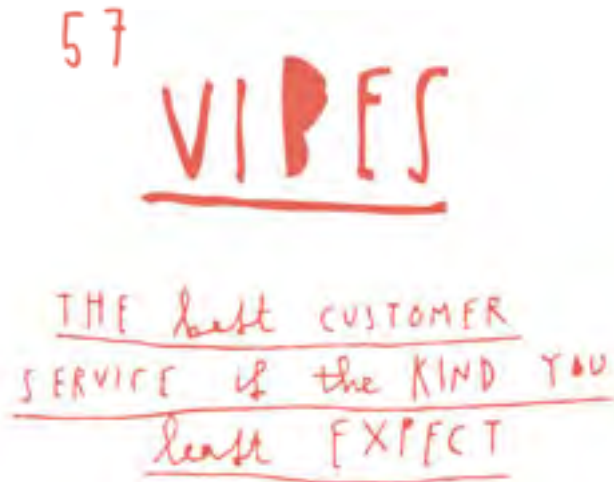

A good place has what some academics call *genius loci*, but we think *vibe* will do. It's the overall atmosphere of a place, the way it communicates what it really is.

It's just as evident in the attention to detail (bins, toilets, benches) as in the mix of things going on (shows, festivals, markets). It's got a lot to do with design, but it's overlaid with how people behave in a place – that gives the game away more than anything.

If they look and act tense or uncomfortable, chances are the place is a bit hyped up too. But if they look and act happy and relaxed, that's the perfect vibe for us.

But how do you orchestrate that?

Atmosphere sounds like a pretty vague and elusive aspiration for an emergent place brand. But it's vital. They do it in the theatre and in the film industry – using lighting, sound, setting, special effects. So why not in an urban setting?

There are proven theories about the effect of pleasant smells in shopping centres and supermarkets – coffee roasting and bread baking being amongst the most effective – so why not take things further at Battersea?

It's got to do more than it says on the tin, giving off an inviting and interesting vibe to a broad and discerning range of people. It's got to convey its core values in the way you enter the buildings, wander around the spaces and are made to feel welcome.

For us, that's about incorporating great signage, fun outdoor furniture, dramatic and subtle lighting and even more exciting events, so that the immediate impression when you arrive is strong and characterful and unmatched by any other city neighbourhood.

**FACT:**

An experiment conducted by psychologists at the University of British Columbia looked at how the colour of interior walls influences the imagination. The study found that a blue wall helped to double a subject's creative output compared to a red wall.

58

Care +

Cast your mind back. Incredibly, only a couple of decades ago standards of customer care in this country were pretty dire. It can still be a bit hit and miss in some places, it's true, but on the whole we've made great strides. Take the John Lewis Partnership or the Virgin Group. They have developed a loyal brand following because of the level of care they offer their customers. They've set the bar pretty high but we plan to get Battersea Power Station one step beyond.

Along with rising levels of customer care, our expectations go up too. Once we know what it's like to be treated well in one place, we hope and even expect it to happen in the next. Witness the trend of adding more stars to the hotel spectrum: at one time, the top of the tree was a five star establishment, defining the height of luxury, setting the standard for others to follow. And the thing is, they did. Three and four star hotels raised their game accordingly and before long the notion of a superior six or even seven star hotel was mooted.

The French have only recently added a fifth star. Some systems, like the Michelin Guide, have limited their ratings and it has only ever seen the need for a maximum of three stars and these are awarded to just over 100 restaurants in the world.

We will eventually be building our own superior quality hotel at Battersea. And of course, we aim to achieve Michelin-starred restaurants. In the meantime, we are making every effort to make the overall experience of just coming down to Battersea, whether as a loyal club member or a casual visitor, one you'd rate 'exceptional, worth a special journey'.

That for us is the embodiment of the notion of care+, evident in how we treat people and functioning as a measure of our success.

Even Mr. Bubbles will know your name.

**FACT:**

The UK is ranked 14th in the International Customer Service Rankings and 34th for customer service according to the World Economic Forum.



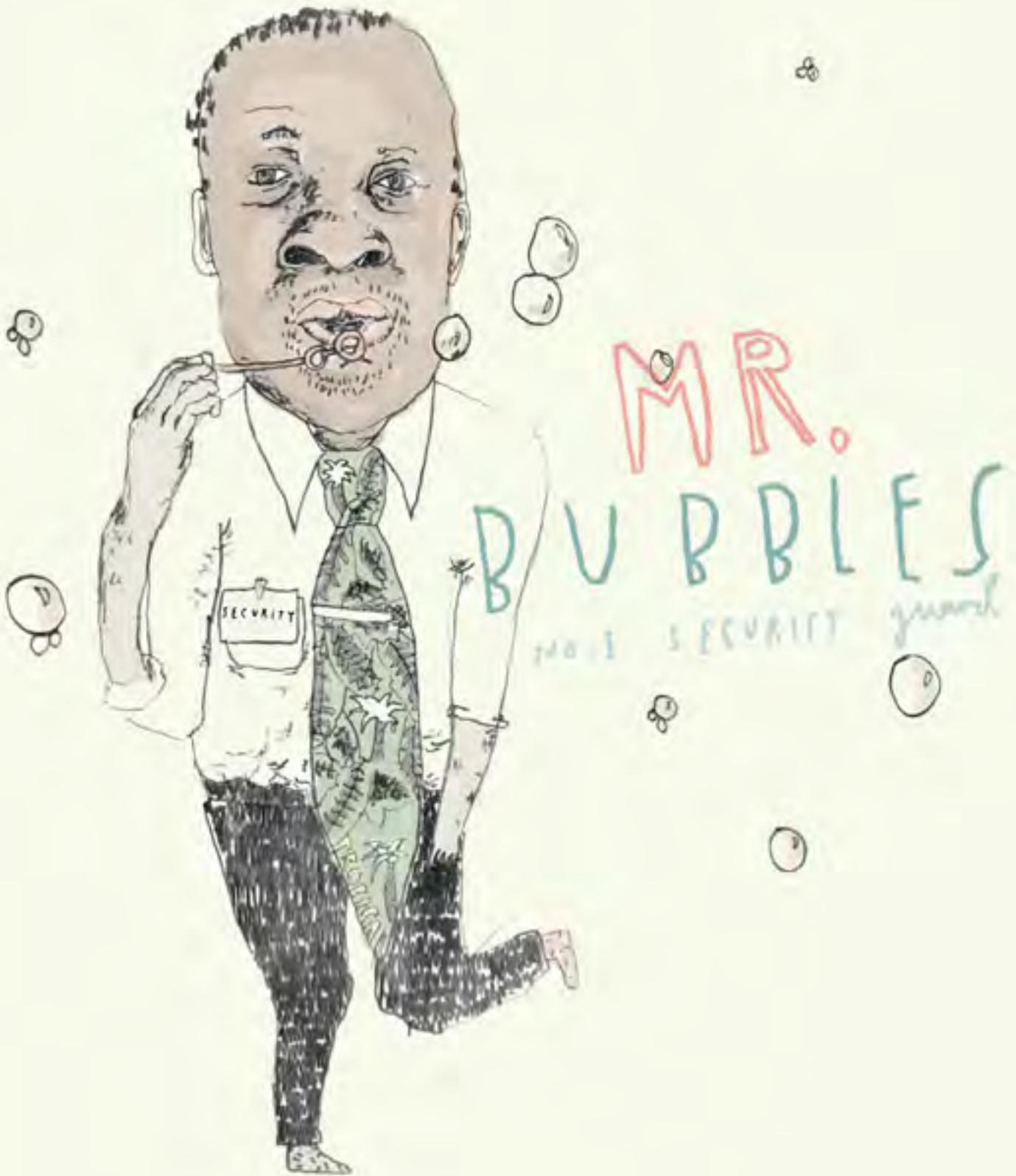



SEX IN A



POWER STATION

59



Let's not get above ourselves. We're not so bullish as to think Battersea Power Station can be built from scratch as a new place brand without the help of some already well-established and influential brands coming on board. The fact is the most convincing indication that a new brand is really going to take off is seeing its associations with others: it's a case of 'if they've got them involved, they must be big news'.

We're in the process of building some lasting and powerful partnerships with a whole range of innovative concepts and companies, who are all potentially future players and major occupants of the site.

But it doesn't stop there – behind the scenes we are also working with some of the world's best agencies, architects, landscape designers, consultancies and design studios to get the job done.

We've been holding competitions and workshops to select not just the right team, but to see who is the most passionate about The Power Station and if we can all work together well. We want to give a clear sign to punters and professionals alike that we are taking our job seriously by hiring the right people to inject high level thinking and challenge the status quo of urban development.

Forging the right sort of partnerships can enhance our place brand and for this to work it's all about synergy and getting the mix just right. Do this right and we'll have everyone lining up out the door when we launch the next phases of the development.

60

## WORD OF MOUTH

If we could always speak highly of the things we've bought or the services we've received, there'd be no need for marketing or advertising. Products and places would just sell themselves.

Word of mouth publicity is a marker of success, because it's honest, spontaneous, highly targeted, viral and exclusive. It drives more than half of our purchasing decisions. But it's not just about spreading the word: word of mouth builds networks and brings people together to form interest groups and other affiliations. It's the social glue and it's happening not just face-to-face – word of mouth is instant messaging, blogging and tweeting.

The trick with Battersea is to make the people who come here our best ambassadors. Yes, we would like journalists and the critics to spread the word to their captive audiences, but ultimately we need an army of independent brand advocates who will create and convey messages which will support and enhance what we're trying to achieve. Becoming a fan on Facebook, tweeting about an event or sharing photos on Instagram for all to see. That's word of mouth – telling people where you've been and what's going on.

For this to happen, we need to offer something compelling and authentic, to keep them interested with an unfolding and soul-stirring story. Because otherwise they'll simply go off and shout about something else.

### **FACT:**

More than 72 hours of video is uploaded to YouTube every minute. London is one of the most active cities on Twitter, ranked 3rd overall behind Tokyo and Jakarta (in terms of share of public tweets at city level).



# getting started

Armed with a masterplan, a project manifesto and 60 Placemaking Strategies – it was time to begin. But where should we start? And what should we build?

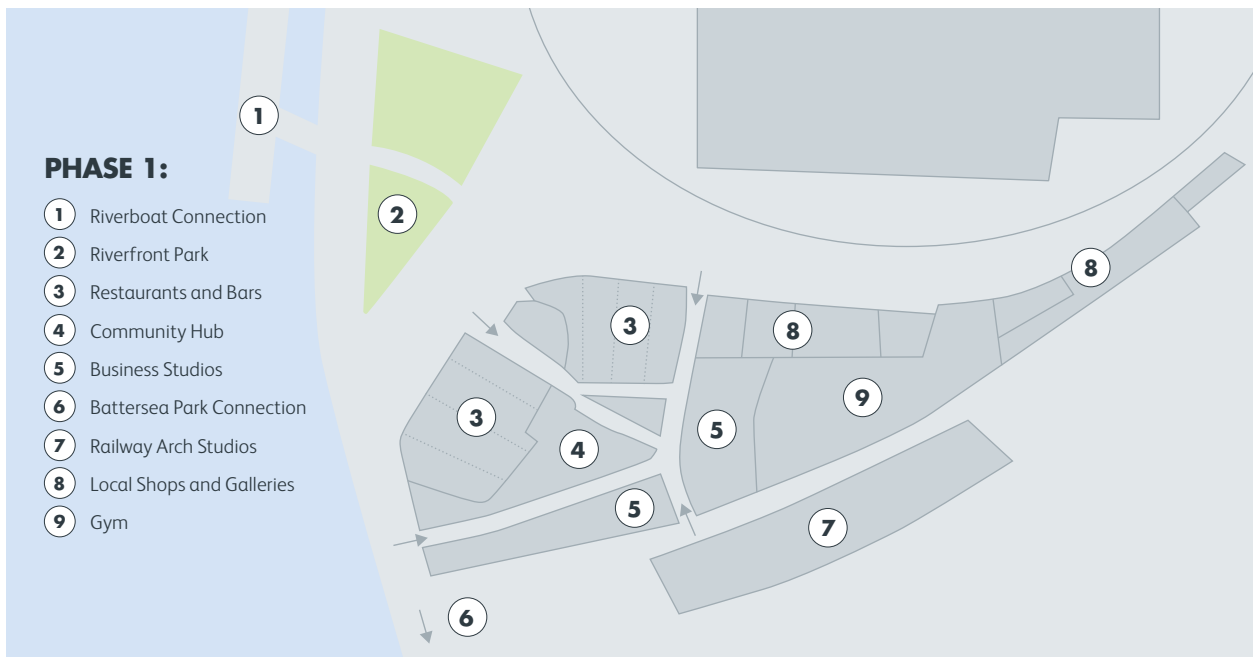

It was clear from the very outset that the restoration of The Power Station could not be our starting point. Requiring vast financial investment and around four years of painstaking work to transform, economics dictated that an enabling phase of development would be needed to fund our undertaking.

This presented us with a Placemaking challenge. We knew that to make the sums add up, the first phase would need to be predominantly residential – but it also needed to anchor an impressive riverside destination and create a sense of place that built anticipation for The Power Station and the opening of the High Street. In effect, Phase 1 needed to serve as a statement of intent, a symbolic action delivering on our promises and a taste of things to come.

A location to the west of the site, adjacent to The Power Station, seemed to fit the bill for an appropriate Phase 1 – technically feasible, large enough to help fund the restoration of the listed building and with great frontages onto the six acre park and River Thames.

You never get  
a second chance  
to make a good  
first impression.

The next challenge for the development team was how to apply our ‘no default’ thinking to procuring a design team and employ a competitive process that would elicit a more joined-up approach to urban Placemaking while simultaneously engendering a real sense of synergy amongst the team.

Most competitions are cut and dried affairs that look for a formal response – architectural beauty parades where entrants rarely come into contact with those commissioning design, let alone each other. We were convinced there must be a better way to go about this – what we were looking for was a great urban experience rather than just some impressive buildings. In collaboration with JTP Cities, we started by selecting a diverse shortlist of designers, whose previous work showed a genuine commitment to Placemaking – great architects for sure – but also interested in the spaces between buildings and the activities that bring people together.

We asked each team to base themselves in our offices for a week and evolve design concepts through a series of workshops with our development team. We figured this would simulate our future working relationship and allow us to identify teams that were sympathetic to our way of thinking and capable of generating ideas in the spirit of The Power Station Manifesto.

Rather than creating an absolute and quantified brief, we issued competitors with a series of challenges that encouraged design exploration, to question assumptions inherent within the masterplan and our own preconceptions. Working in the shadow of The Power Station, in open plan spaces adjacent to one another, the architectural teams were able to rapidly develop ideas, test them with The Power Station team and reach their final schemes within just a few days – rather than weeks or months.

At the end of the week, six remarkably different approaches had emerged and were evaluated against a set of criteria that had formed part of the brief from the outset.

During this stage it became obvious that our initial belief that we were looking to commission a single designer was too simplistic and that by combining the visions of two of the teams – Ian Simpson Architects and dRMM – an altogether more exciting proposition could emerge.

Tackling the challenging front block, which provides the setting for the listed Power Station, Ian Simpson Architects had developed the glacial crystalline properties which the Viñoly plan envisaged into an innovative winter garden facade treatment.

The rear block of Phase 1, facing west towards the railway, required an altogether different response and the ideas put forward by dRMM contrasted well with the front block – offering a different kind of living accommodation and an intimate mews style street with repurposed railway arches.

Fast forward many months, through hundreds of design iterations involving an army of technical consultants and Ian Simpson Architects and dRMM secured planning consent for a remarkable vision.

We think it's been well worth all the hard work – taking time to rethink residential development from first principles and having the courage to make decisions based on what it takes to deliver a great place at Battersea Power Station, rather than fixating on the financial bottom line.

So what should everyone expect?

## MEANWHILE USES

To begin with, the opening of Phase 1 in 2016 is not the start of our Placemaking journey – rather it forms one stage of the 'unfolding story' set out in our Manifesto. Indeed, The Power Station has already been awoken from its 30 year slumber by a sequence of events we have staged over the past few years. From the Freeze Festival to the Chelsea Fringe and all points in between, we have invited people in and begun to reframe Battersea Power Station as a cultural destination in the hearts and minds of Londoners.

Our Pop-Up Park established in summer 2013 has built on this reputation, attracting more than 12,000 people to hang out beside the River Thames or take part in our outdoor yoga and gym classes, with the towering north facade of The Power Station as a backdrop. These meanwhile uses and others, such as outdoor cinema/theatre performances and family events, will continue to animate the site and help build habitual usage amongst local people while we get on with the business of construction.

When Phase 1 opens for business in 2016, our visitors will experience a shift from ephemeral Placemaking to something permanent and the beginning of what they will recognise as an authentic London quarter. Over the last couple of years, we've studied some of the great neighbourhoods in the capital to understand what makes them tick – and why they have become wonderful places to live, work and visit.





## URBAN VITALITY

We feel the key to this is striking the right balance with the mixed uses, providing essential services for the local residents and businesses, as well as culture and leisure facilities that make them characterful and attractive to visitors. Providing these elements from the very outset is what will distinguish The Power Station from other developments in London and make it a thriving urban place.

Few investors would be willing to make this kind of commitment in the first phase of a project. Commercial inducements will be needed to attract the right kinds of tenants before The Power Station opens and the crowds flood in. But we figure this is a small price to pay for success over the longer term. This is why the first residents on the site will have remarkable local shops right on their doorstep (*19. Bread & milk*) – as we seek to secure a fresh food store, fishmonger, butcher, cheese shop and vintner.

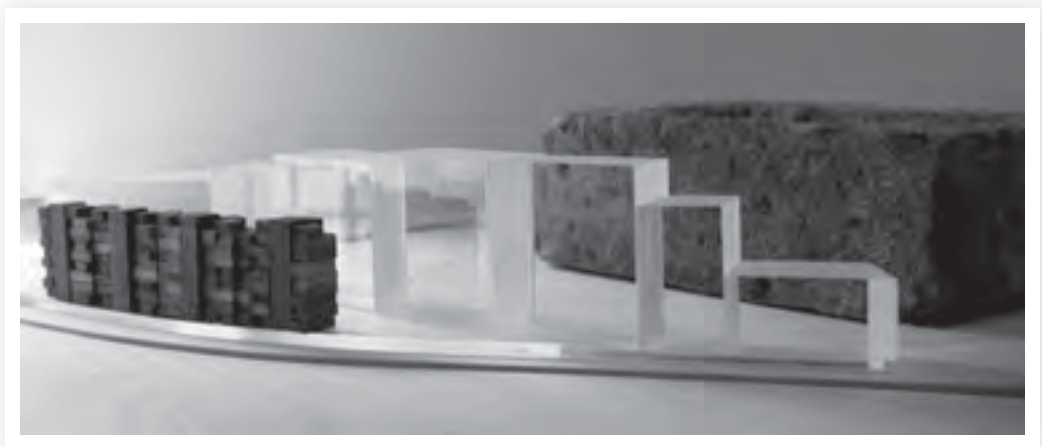

## MAKING BATTERSEA

The procurement of Phase 1 began with an open ideas competition and ended with the selection of two firms of architects, Ian Simpson Architects (top) and dRMM (below), whose concept models are shown here.

We're also working on a unique riverside dining offer for Phase 1 – eight restaurants not found elsewhere in the capital – in a riverside setting and catering for all tastes and budgets (*13. What's on the menu*).

While these eateries will animate the street in the evenings and at the weekends, a workforce occupying 30,000 sq ft of business space will help bring the area to life during the day. Located under the courtyard garden and in the refurbished railway arches in the mews alongside the dRMM building – this will include workshops and studios for creative industries and help encourage innovation on the site.

With the major leisure facilities not due until The Power Station is delivered, we were keen to establish a dynamic social/cultural hub in Phase 1 to act as a focus for the pioneer community. This takes the form of a flexible multi-purpose space capable of being programmed 365 days per year and hosting every imaginable activity from residents' meetings, dance classes and lectures, through to traditional forms of entertainment like recitals, stand-up comedy, gigs and films.

## NEIGHBOURHOOD SPIRIT

With over 800 new homes occupied by 2,000+ residents, we wanted to ensure Phase 1 would have a mixed demographic, to kick start a healthy community from day one. So we've ensured new homes come in all shapes and sizes, from studios right up to four bedroom townhouses with their own private garden (*31. Different as standard*).

Residences closely follow the strategies in The Placebook, allowing personalisation (*34. A place of my own*) and flexibility (*35. Transformation*). Sliding walls and winter gardens can transform a one bedroom flat into a dining space for eight of your nearest and dearest and storage, the greatest bugbear of new purchasers, is carefully integrated into all rooms (*36. Deal with my crap!*).

We pushed the architects especially hard on the design of communal spaces and facilities, which we felt were key to encouraging sociability and nurturing a community spirit. As a result, corridors and lobbies have been enlarged and turned into places people can linger and chat and a suite of spaces have been created to provide the residents of Phase 1 with a focal point for meeting.

All too often these community spaces are put in low value and inaccessible locations or tucked away behind closed doors, so they are rarely used or loved. But in Phase 1 we felt strongly enough about the importance of social mixing to give up three floors of prime frontage with an amazing view of The Power Station.

Here you will find the community's living room – a place to relax, entertain and meet with the neighbours.

With a concierge, bar and lounge, library, cinema and party room (*37. Living+*) we see this as the place our new community can be nurtured and take shape – when the weather is nice, find some peace and quiet (*15. Sanctuary*) away from the millions of visitors who will come to The Power Station, in their very own garden courtyard.

As we worked through these community building strategies for Phase 1, we realised this needed to be considered at the scale of the entire project and have created our own **Community Charter**: ten significant commitments we will undertake over the coming years to build social capital in our new urban quarter.

---

# BATTERSEA POWER STATION COMMUNITY CHARTER

Creating a Community Charter at this early stage of the Battersea Power Station development ensures that the social aspects of good Placemaking will become the bedrock of the project and do not get ignored or left to chance. This Charter, with ten commitments, develops specific strategies that address today's social issues and acts as a warranty to future residents and occupiers that we take our long-term role in the success of the neighbourhood extremely seriously.

The ten commitments will build a strong, robust and sustainable community at Battersea Power Station through:

---

**PLACE  
DESIGN**



---

**BUSINESS  
COMMUNITIES**



---

**CONNECTIVITY  
& ACCESS**



---

**SAFETY**



---

**SUPPORT  
& PROGRAMMING**



---

**TECHNOLOGY  
& NETWORKS**



---

**THIRD PLACES**



---

**GOVERNANCE**



---

**SOCIAL CAPITAL**



---

**EXISTING  
COMMUNITIES**





## RESTORING THE ICON

Realising Phase 1 is a complex and demanding task in its own right – but of course we have already turned our attention to the more critical task of restoring The Power Station.

Using a competition format akin to Phase 1, we identified Wilkinson Eyre as ideal architects to oversee the transformation of the building. With many years expertise in handling buildings by Sir Giles Gilbert Scott (the new Bodleian Library) and a keen understanding of post-industrial Placemaking (The Magna Centre) the building is at last in safe hands and new designs are progressing at speed.

We've also been busy with our historical research and detective work. The Power Station chimneys – in poor shape because they were built with river water – are being rebuilt to the original designs and using drawings discovered in the archives and our knowledge of the original 'slip-form' technique of construction, we are aiming for a 100% accurate reconstruction of the iconic Power Station skyline.

Considerable time has also been spent pursuing an appropriate brick supplier for The Power Station repairs, which paid off when the original supplier was miraculously tracked down and turned out to be a small village brickworks in the Midlands.

They're delighted to be able to assist us in the restoration of the building and will be using the same clays, mix and coal-fired kilns to produce the brick. This means we are no longer talking about accurate matching, but rather 'like-for-like' repair and replacement wherever this is deemed necessary.

We feel it's safe to say that 30 years of dereliction and despair are finally coming to an end and are pleased to report that despite all of the false starts and setbacks, Battersea Power Station has maintained its popular huge appeal and we are not resting on our laurels. We have recently appointed Frank Gehry and Foster + Partners to design new icons to sit boldly alongside The Power Station.

At Open House in 2013 more than 40,000 people came to see the building in a single weekend – standing excitedly in line for the chance to glance inside one last time before its restoration. Even better from a funding perspective, this enthusiasm has translated into sales – with a record number of UK purchasers interested in Phase 1, with many braving temperatures of -4 degrees at 7am on a cold January day to become a part of our vision.

It may still be early days, with years of effort ahead – but for Battersea Power Station, dark for decades – the future looks bright.

nurturing  
talent

Battersea Power Station will be a place that welcomes and incubates culture and creativity, which in turn serve to bring the Grade II\* listed building and its surrounding area to life.

At the heart of this Placebook lies the intention to practice what we preach. By commissioning talented up-and-coming art students to illustrate our manifesto and our strategic thinking for the project, we have begun to action one of our key aspirations: *Culture, Culture, Culture*. To develop this relationship we have worked closely with Mark Davy from Futurecity and the team at JTP Cities.

We chose on this occasion to work with staff and students from the University of the Arts London, which is one of the UK's leading arts universities, comprising six colleges and a diverse student population of 20,000. The university was keen to participate in the venture and put out a call for entries for the Battersea Power Station Placebook to all students enrolled at three of its colleges: Camberwell College of Arts, Chelsea College of Arts and Wimbledon College of Arts. Students from a wide range of courses including graphic design, fine art, theatre design and textile design and from across all levels from foundation to masters, responded to the call. The development team and JTP Cities set up a selection panel which included Professor Chris Wainwright (Head of Camberwell, Chelsea and Wimbledon Colleges), Kate Sedwell, (CCW Project Assistant) and Paul Oakley, a professional illustrator who is also a tutor at the University of the Arts London.

From the initial round of submissions we selected nine students who were then briefed by JTP Cities and mentored by Paul. Each student was given their own section of The Placebook to work on and the brief called for a distinctive set of illustrations that would give them the scope to further develop their own style and add to their portfolio of coursework. The illustration process was as much about bringing the words of The Placebook to life as it was about nurturing some of London's developing talents. It's been a very enjoyable and fruitful process and we look forward to collaborating with the University of the Arts London again in the future.

## ALUMNI

### CCW Notable Alumni

Quentin Blake (*children's illustrator*)  
Anthony Caro (*abstract sculptor*)  
Georgina Chapman (*actress, model and designer*)  
Peter Doig (*painter*)  
Guy Hendrix Dyas  
(*designer and BAFTA nominated feature film designer*)  
Ralph Fiennes (*actor*)  
Anish Kapoor (*1991 Turner Prize winner*)  
Steve McQueen (*1999 Turner Prize winner*)  
Mariko Mori (*artist*)  
Chris Ofili (*1998 Turner Prize winner*)  
Alan Rickman (*actor*)  
Gavin Turk (*artist*)  
Mark Wallinger (*2007 Turner Prize winner*)  
Gillian Wearing (*1997 Turner Prize winner*)  
Roger 'Syd' Barrett (*musician of Pink Floyd*)  
Howard Hodgkin (*1985 Turner Prize winner*)  
Laurence Llewelyn-Bowen  
(*interior designer and TV presenter*)  
Malcolm Morley (*1984 Turner Prize winner*)  
Tim Roth (*Oscar-nominated actor*)  
Florence Welch  
(*lead singer in the band Florence and the Machine*)  
James Acheson  
(*costume designer and triple Oscar winner*)  
Raymond Briggs (*author*)  
Jeff Beck (*musician*)  
Georgina Chapman  
(*co-founder of fashion label Marchesa*)  
Tony Cragg (*1988 Turner Prize winner*)  
Peter Doig (*1994 Turner Prize nominee*)  
Sarah Greenwood  
(*production designer and Oscar nominee*)

# Illustrators:

## Konstantinos Palaiologos

Konstantinos lives the good life by drawing and making people laugh. His works are brought to life using digital media as well as traditional printmaking and drawing. In the past he has worked as a graphic designer; he holds a Master's of Engineering and a Master's of Arts.

Email: [kpalaiologos@gmail.com](mailto:kpalaiologos@gmail.com)  
[www.studio-empire.com](http://www.studio-empire.com)



## Jung yun Roh

J Roh (Jung yun Roh) was born in Seoul, Korea and studied at Hongik University, where she received a MFA and BFA. She also studied MA Fine Art at Chelsea College of Arts, University of the Arts London.

J Roh works in all kinds of drawing and painting materials and explores the theme of place by examining 'reconstruction' building sites in the city. Most cities have their own specific character and distinctive identity based on their history and culture. However, building sites coexist with the past, present and future although ultimately the present is the building site itself. She is capturing the present which is a moment where something is disappearing and simultaneously a moment where something is being created. Her primary way of working is through direct drawing which is a crucial way for her to capture vivid and live atmosphere.

Email: [jroh2010@gmail.com](mailto:jroh2010@gmail.com)  
[www.jyroh.com](http://www.jyroh.com)



## Miglena Minkova

Miglena is a recent BA Graphic Design graduate from Camberwell College of Arts, University of the Arts London. Conceptually driven by research, her emerging practice is concerned with the importance of decision-making in the design process. She attempts to incorporate playfulness, randomness and systematic thinking, leading to the creation of complex interpretations of visual and textual content.

With a background in stage design, puppetry and props, she enjoys illustration enormously as an immediate and imaginative storytelling medium. For the 'playing' chapter of the book, Miglena focused on creating a speculative departure point for the possible uses of the regenerated area, depicting fictional situations filled with whimsical characters and activities.

Email: [hello@miglenaminkova.com](mailto:hello@miglenaminkova.com)  
[www.miglenaminkova.co.uk](http://www.miglenaminkova.co.uk)

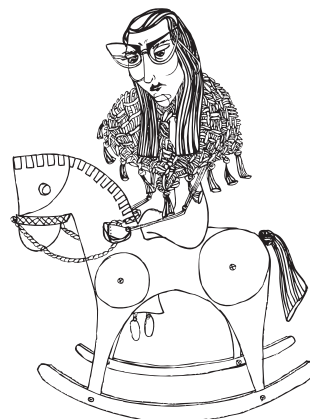





### **Aurora Moreno Pavón**

Aurora was born in Southern Europe in 1989. Bored in a small town where nothing exciting seemed to happen, she decided to move to Portugal in order to start a new phase in which graphic design would be the main focus. After these wonderful years taking advantage of the good life in Porto, she started her 'euro-adventure' partly motivated by her new passion for illustration and her will to conquer the bigger cities. Currently she's somewhere quiet, working on her masterplan to become a unique illustrator and textile designer, while enjoying the nights painting and dreaming about her perfect studio.

Email: [hello@oror.es](mailto:hello@oror.es)  
[www.cargocollective.com/oror](http://www.cargocollective.com/oror)



### **Nick Alston**

Nick is a freelance illustrator currently based in Edinburgh and he enjoys creating work that makes people smile or scratch their head. After studying Illustration at Duncan of Jordanstone (Dundee) he then undertook a master's at the Camberwell College of Arts. Since graduating, Nick has worked with a variety of clients including The Victoria & Albert Museum, Anorak Magazine, T Shirt Store, Belly Kids and Oh Comely.

Email: [nick\\_alston@hotmail.com](mailto:nick_alston@hotmail.com)  
Twitter: [@nicholas\\_alston](https://twitter.com/nicholas_alston)  
[www.nickalston.co.uk](http://www.nickalston.co.uk)



### **Sally Lewis**

Sally has a keen interest in participation and enjoys working with communities and groups of people to produce creative work. For this project, she worked with people and places local to her home to build up a collection of photographs from which to take inspiration. Sally is about to enter her final year on the Graphic Design Communication course at the Chelsea College of Arts and looks forward to the highs, lows and general madness that will inevitably ensue. For Sally this project has involved:

1,031 photographs  
1 near broken ankle  
A happy time was had

Email: [sallygracelewis@gmail.com](mailto:sallygracelewis@gmail.com)  
[www.cargocollective.com/sallylewis](http://www.cargocollective.com/sallylewis)

# Illustrators:

## **Georgina Bing Han**

Georgina Bing Han was born in China. She is a graphic designer, illustrator and TV packaging designer. She has worked for the Beijing Daily as an art editor. Currently, she works for Dalian TV Press Center (DLTV), making programmes' promos and total packaging. She also does freelance illustration work. Her illustration work involves using both computer and hand drawing and her typical process includes print making, watercolour or mono-line drawing that she scans and re-creates digitally.

She completed her Bachelor's degree in Visual Communication Design at Tsinghua University in Beijing. After that, she moved to London and studied on an MA Illustration course at Camberwell College of Arts, University of the Arts London.

Email: [Bhan05@gmail.com](mailto:Bhan05@gmail.com)



## **Gabriella Voyias**

Gabriella is a recent graphic design graduate from the Chelsea College of Arts, University of the Arts London. During her three years at Chelsea she had the opportunity to explore many areas within design and occasionally drew as a hobby.

She enjoys tackling creative briefs and the process of problem solving. In the last few years she has taken an interest working in print and publishing.

Email: [gabriellavoyias@gmail.com](mailto:gabriellavoyias@gmail.com)  
[www.gabriellavoyias.com](http://www.gabriellavoyias.com)



## **Bradley Bell**

Bradley completed a BA Graphic Design Communication course at the Chelsea College of Arts, University of the Arts London.

Bradley enjoys communicating a message that people can understand and relate to by visual means. He's completely enchanted by good design and consistently strives for fresh ideas and improvement. With utmost enthusiasm, he always tries to make things happen and maintain ambition in all projects.

Bradley tries to indulge in as many medias as possible, though he particularly enjoys illustration, print making, animation and film. Everything starts out on paper and eventually gets polished by digital means. He's delighted in the creative process and the exciting development that comes from responding to a brief and solving a problem.

Email: [bradley@illustratedpeople.com](mailto:bradley@illustratedpeople.com)



# Placebook credits:

Artwork and layout design: JTP Cities and Wordsearch

Masterplan illustration and map on pages 174–175  
by Peter Reynolds of Follow the Lights:  
[www.followthelights.co.uk](http://www.followthelights.co.uk)

To download a copy of The Placebook visit  
[www.batterseapowerstation.co.uk](http://www.batterseapowerstation.co.uk)

## Back story

Page 08

Sir Giles Gilbert Scott, RIBA Library Photographs Collection

Page 09

Top: ©Crown Copyright 1874-1880

Bottom: Battersea Power Station, London: the north west corner of Battersea 'A' under construction, RIBA Library Photographs Collection

Page 10

The Boiler House 1947

Page 11

The Battersea Power Station of the London Power Company LTD

Page 12

Top: Photograph Turbine Hall A from Control Room Balcony ©Randolph Langenbach for SAVE Britain's Heritage, 1981, [www.conservationtech.com](http://www.conservationtech.com)

Bottom: ©Wolfgang Suschitzky/Museum of London, Battersea Power Station 1958

Page 13

Top: ©English Heritage (Aerofilms collection)

Middle: Interior, 13 February 1947

Bottom: Control Room A, February 1976, taken for CEGB SE Region

Page 14–15

Photographer Patrick Walmley, 27 April 1987

## List of merchandise

Row 1 (Left to Right)

*London Buildings: An Architectural Tour* by Robin Farquhar and Hannah Dipper (Batsford Ltd), 2011

Sambrook's Brewery: [www.sambrooksbrewery.co.uk](http://www.sambrooksbrewery.co.uk)

*Modernism London Style* by Christoph Rauhut (Hirmer Publishers), 2013

Jacky Al-Samarraie of The Art Rooms:  
[www.theartrooms.co.uk](http://www.theartrooms.co.uk)

Row 2 (Left to Right)

Paul Catherall: [www.paulcatherall.com](http://www.paulcatherall.com)

For All We Know: [www.forallweknow.co.uk](http://www.forallweknow.co.uk)

Pink Floyd *Animals* (inside artwork)

Row 3 (Left to Right)

Another Studio: [www.another-studio.com](http://www.another-studio.com)

Pink Floyd *Animals*

Hannah Louise Lamb: [www.itchyfingers.org/hannah](http://www.itchyfingers.org/hannah)

Landscape: [www.landscapeskateboards.com](http://www.landscapeskateboards.com)

Row 4 (Left to Right)

Popupology: [www.popupology.co.uk](http://www.popupology.co.uk)

Jack Howse: [www.jackhowse.co.uk](http://www.jackhowse.co.uk)

London Borough of Wandsworth London  
2012 Olympic Badge

Row 5 (Left to Right)

Snowden Flood: [www.snowdenflood.com](http://www.snowdenflood.com)

Jack Howse: [www.jackhowse.co.uk](http://www.jackhowse.co.uk)

*Brick City: LEGO® for Grown Ups* by Warren Elsmore (Mitchell Beazley), 2013

# The Placemakers:

The consortium behind the development is comprised of three shareholders.

## S P Setia Berhard

Since its incorporation in 1974, S P Setia Berhard has been a household name in Malaysia's property development industry. The group is recognised as Malaysia's leading listed real estate player with a portfolio that encompasses new towns, eco-sanctuaries, luxury enclaves, high-rise residences, integrated commercial and retail developments.

In 2012, S P Setia Berhard was ranked No.1 in The Edge Malaysia Top Property Developers Awards for the 7th time, the only developer to have achieved this feat since the inception of the awards. S P Setia Berhard is also the only Malaysian developer to be recognised five times by the International Real Estate Federation (FIABCI) for three Best Master Plan Developments, one Best Residential (Low-Rise) Development and a Best Purpose-Built/Specialised Project award.

The group's strength lies in its prowess in creating meaningful environments based on its development philosophy of Live Learn Work Play. Having built a solid base in Malaysia, S P Setia Berhard began spreading its wings overseas in the last five years and is now in Vietnam, Australia, Singapore, China, Indonesia and the United Kingdom.

## Sime Darby Property

Sime Darby is a Malaysia-based, diversified multinational involved in key growth sectors, namely plantations, property, motors, industrial equipment, energy and utilities and healthcare. Founded in 1910, its business divisions seek to create positive benefits in the economy, environment and society where it has a presence. With a workforce of over 100,000 employees in over 20 countries, Sime Darby is committed to building a sustainable future for all its stakeholders.

Sime Darby Property, the property arm of Sime Darby, is an established integrated property group, focused on becoming the leading developer of sustainable communities, in line with Sime Darby's brand positioning of developing sustainable futures. The core businesses of the division are property development and property investment. Apart from Malaysia, it has a global reach that encompasses assets and operations in Australia, Singapore, United Kingdom and Vietnam.

## The Employees Provident Fund

Set up in 1951, the Employees Provident Fund (EPF) is a social security institution which provides retirement benefits for members through management of their savings in an efficient and reliable manner.

As a retirement fund, the EPF adopts a risk-based investment approach and is committed to maintaining a prudent and low risk investment policy to safeguard members' retirement funds.

Members' contributions are invested in a number of approved financial instruments to generate income. They include Malaysian Government Securities, Money Market Instruments, Loans and Bonds, Equity and Property. Investment decisions require the approval of the EPF Investment Panel whose members are appointed by the Minister of Finance.

The EPF is also directly involved in financing national infrastructure projects to provide facilities and amenities to the public such as highways and airports.

The EPF is Malaysia's premier retirement savings fund serving more than 13 million members and is ranked among the largest sovereign pension funds in the world.

As of June 2012 the EPF has a total of 13.35 million members.

Builder of Distinction  
**Setia**  
S P SETIA BHD GROUP

**Sime Darby**  
Developing Sustainable Futures  
**Property**

 Employees Provident Fund



Battersea Power Station is one of the largest regeneration projects to be undertaken in Europe, let alone in central London, and has been a long while in the making. That's why Battersea Power Station Development Company decided to approach things a bit differently.

This Placebook is the culmination of years of work with JTP Cities, involving significant creative participation from industry leaders and the University of the Arts London, to bring together a range of innovative thinking in relation to a challenging urban site, with one of London's best known landmarks at its heart. By taking into consideration how people will want to live, work, shop, play, learn and connect, it presents a fresh and unique take on how to evolve a derelict piece of industrial infrastructure over a 15 year time span into a flagship piece of Placemaking fit for the 21st century.

In short, it sets out what we are going to do, how we are going to pull it off and why people will want to come.

